

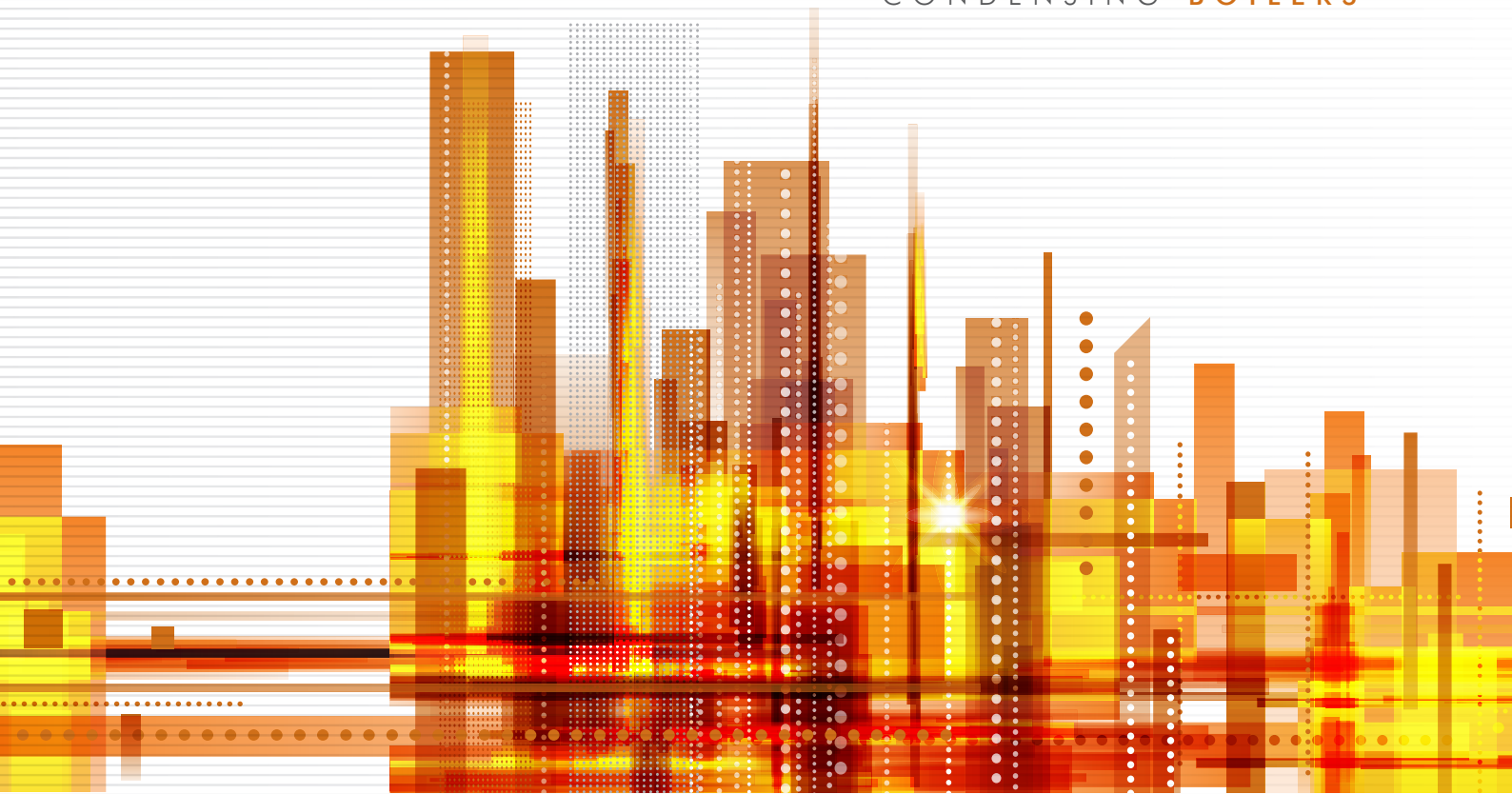

ethos

CONDENSING BOILERS



ETHOS 350 & 550 FLOOR STANDING CONDENSING BOILERS
TECHNICAL DOCUMENTATION
ISSUE **03/18** Rev. 02

TABLE OF CONTENTS

1.	Technical Data	04	Switching On the Appliance	24
			Switching Off the Appliance	
2.	Dimensions	05	Information Display	25
3.	Safety Guidelines	06	DHW Operation	
	Conditions		Heating Operation	
	General Guidelines		Displaying Information	
	Service	07	Table Parameter List	
	General Restrictions		History Mode	26
			Possible Error Codes	
			Possible Error Codes continued.	27
4.	Description	08		
	General			
	Working Principle and Design			
	Application Features			
	Main Components	09		
	Rear Connections			
	Boiler Control	10		
	Safety Aspects			
5.	Delivery & Transport	11		
	Delivery			
	Transport			
	Moving			
	Access Requirements			
6.	Installation	12		
	Regulations			
	Installation Guidelines			
	Ventilation	13		
	Gas Connection			
	Water Connections			
	Electrical Connections			
	0 - 10 V Control			
	Internal Controls Breakdown (Main PCB)	14		
	Internal Controls Breakdown (Control Fascia)	15		
	External Controls Breakdown (Din Rail)			
	Controls and Options	16		
	Flue Connection	17		
	Condense Removal			
	Flue Length	18		
	Calculation of Diameter and Length			
	Condense Connections	19		
	Safety Valve Connection			
	Hydraulic System			
	Shut-Off Valves	20		
	Valves (Boilers in Cascade Arrangement)			
	Draining and Cleaning			
	Water Circulation System			
	Water Pressure	21		
	System Expansion Vessel			
	Water Pressure Protection Device			
	Water Temperature			
	Water Quality			
	Water Hardness	22		
7.	Operating Instructions	22		
	Operation			
	Controls			
	Boiler Module	23		
	PCB Symbol Key			
8.	Commissioning	28		
	General			
	Reference Value for Maximum Load			
	Reference Value for Minimum Load			
	Maximum Load Adjustment	29		
	Minimum Load Adjustment			
	Setting the CO ₂ Value for the ETHOS Range	30		
	Conversion from Natural Gas to Propane	31		
9.	Cascade Set-Up	31		
	Auto Detection Mode			
	Cascade Test Mode	32		
10.	Maintenance	33		
	Safety			
	Servicing Schedule			
	Removal of Gas Valve and Venturi	34		
	Removal of Fan and Burner Assembly	35		
	Setting / Checking of Electrode and Probe Gaps	36		
11.	Component List	37		
	Casing and Electrical Components			
	Core Components	38		
12.	Conversion Formulae & Factors	39		
13.	Notes	41		

TECHNICAL DATA

GENERAL			
Dimensions (Height x Width x Depth) ^[1]	mm	1300 x 750 x 1100	1300 x 750 x 1500
Model		ETHOS 350	ETHOS 550
Water Content of Appliance	litre	25	30
Weight (Empty)	kg	234	370
Flow / Return Connections	BSP	DN50 PN16 Flange	DN65 PN16 Flange
Gas Connection	BSP	1½"	1½"
Flue Connection	mm	150	180
Power Consumption	W	558	898
Electrical Supply	V	230	230
Frequency	Hz	50	50
Fuse Protection	A	10	10
Maximum Fan Speed	RPM	5900	9200
Minimum Fan Speed	RPM	1100	1950
HEATING PERFORMANCE			
Nominal Heat Input (Nett)	kW	17.5 - 350.0	27.5 - 550.0
Nominal Heat Output at 80/60°C	kW	17.2 - 343.0	27.0 - 539.0
Nominal Heat Output at 50/30°C	kW	18.9 - 378.0	29.7 - 594.0
Maximum Gas Consumption	G20	m³/hr	35.5
	G25	m³/hr	40.4
	G31	m³/hr	13.6
			56.1
			62.1
			20.9
TECHNICAL DATA			
Flue Gas Dew Point	°C	52	52
Flue Temperature at 80/60°C (at ambient temperature of 20°C)	°C	75	75
Flue Material Temperature Class		T 120	T 120
Permitted Maximum Resistance of Flue System ^[2]	Pa	200	250
Condensation pH Value		3.0 - 5.5	3.0 - 5.5
Maximum CH Flow Temperature	°C	90	90
CH Water Pressure (Minimum / Maximum)	bar	0.5 - 6.0	0.5 - 6.0
Minimum / Maximum Gas Pressure	G20	mbar	17 - 20
	G25	mbar	17 - 20
	G31	mbar	30 - 50
			17 - 20
			17 - 20
			30 - 50
ENVIRONMENTAL DATA			
NO _x Levels	mg/kW	31.0	31.0
Maximum Efficiency (Nett Non-Condensing)	%	98.1	98.3
Maximum Efficiency (Nett Condensing)	%	108.9	108.6
Seasonal Efficiency	%	95.6	95.6

^[1] Depth dimensions are taken from the front to the rear of the casing and do not include the external pipework. Height dimensions are taken from the bottom of the boiler and do not include the height of the supplied adjustable feet.

^[2] With this resistance value the heat output will remain within the specifications indicated on the dataplate; if the resistance is higher, the heat output will be reduced.

DIMENSIONS

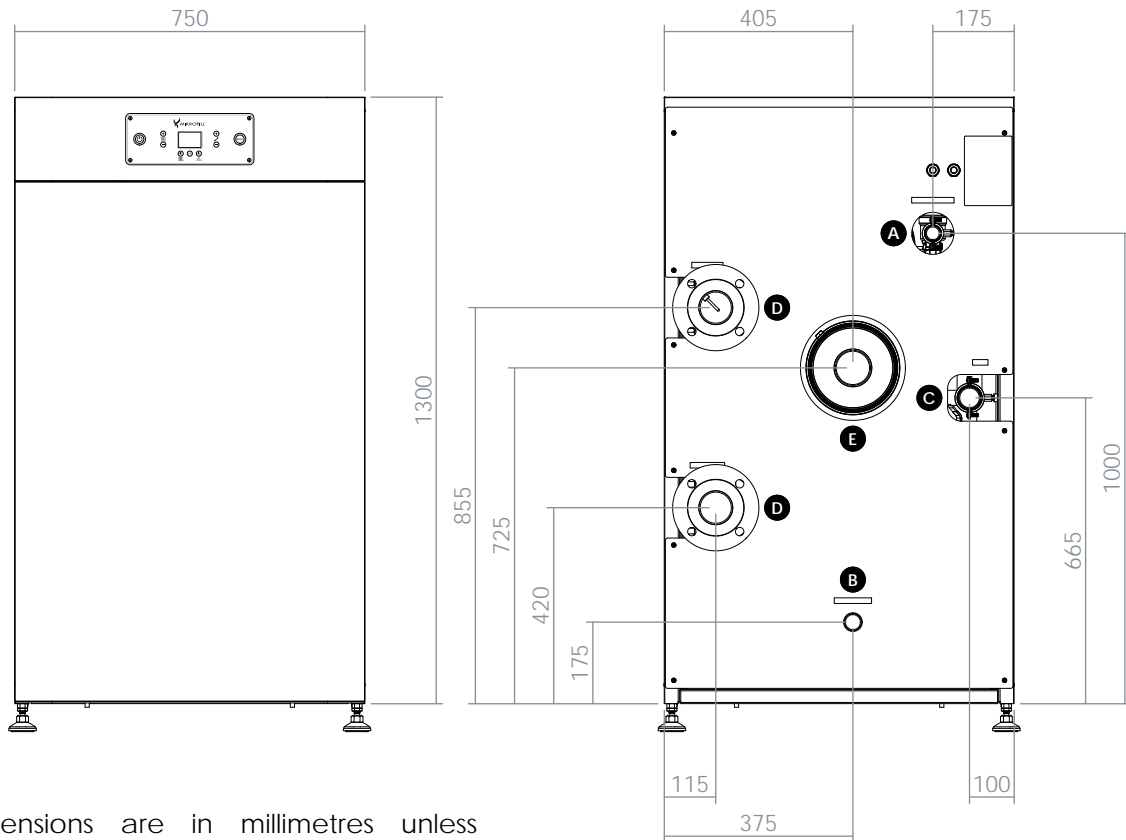

- All dimensions are in millimetres unless otherwise specified.
- Depth dimensions are taken from the front to the rear of the casing and do not include the external pipework.
- Height dimensions are taken from the bottom of the boiler and do not include the height of the supplied adjustable feet.
- Data may deviate slightly due to fabrication tolerances.
- We reserve the right to make changes without prior notification.

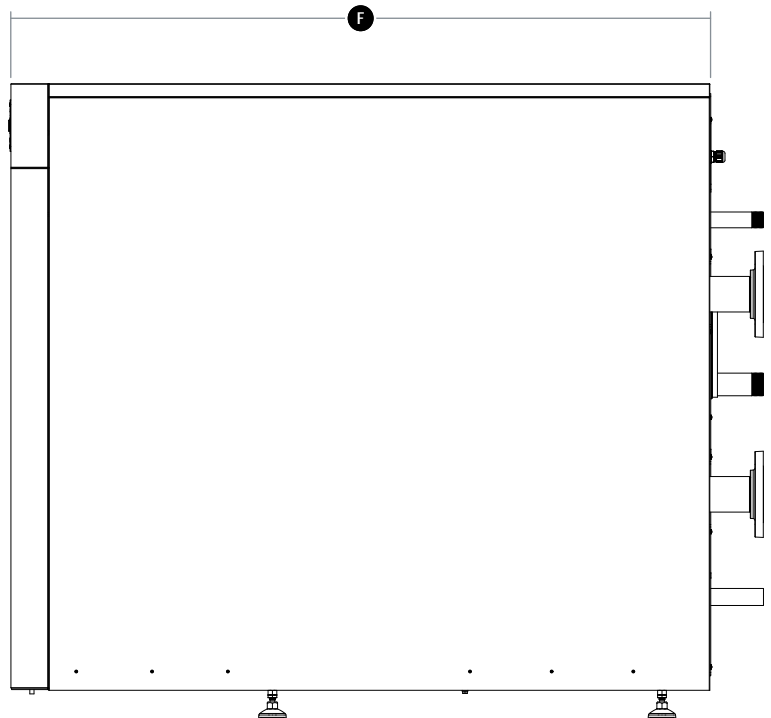

▲ FIGURE 01. DIMENSIONS OF THE ETHOS FLOOR STANDING BOILERS.

		ETHOS 350	ETHOS 550
A	in	1"	1"
B	mm	Ø 32	Ø 32
C	in	1½"	1½"
D	in	2"	2½"
E	mm	Ø 150	Ø 180
F	mm	1100	1500

SAFETY GUIDELINES

CONDITIONS

Mikrofill Systems Ltd. shall not be liable for any damages caused by non-compliance with this manual's instructions. Only original parts must be used for service purposes.

GENERAL GUIDELINES

The appliance is not intended for use by persons (including children) with reduced mental, physical or sensory capabilities, or lack of experience or knowledge, unless they have been given supervision or instruction concerning the use of the appliance by a person responsible for their safety.

It is a statutory requirement that all gas appliances are installed in accordance with the manufacturer's instructions and all regulations in force. All instructions should be fully read before installing or using the appliance. All installations should be carried out by competent persons as described in the Gas Safety (Installation and Use) Regulations i.e. Gas Safe registered and holding current certification.

The manufacturer's instructions **MUST NOT** be taken in any way as overriding statutory obligations.

This boiler has been tested and certified to comply with all necessary European directives, latest building regulations and efficiency requirements, is CE marked and complies with;

- 2009/142/EC Gas Appliance Directive.
- 2014/30/EU Electromagnetic Compatibility Directive.
- 2014/35/EU Low Voltage Directive.

This boiler should be installed in compliance with;

- Building Regulations.
- Building Regulations (Scotland-Consolidated).
- Building Regulations (Northern Ireland).
- The Health and Safety at Work Act.
- Gas Safety (Installation and Use) Regulations.
- Water Fittings Regulations or Water By-laws in Scotland.
- Local Water Company By-laws

The boiler should not be modified in any way. Any modifications will invalidate the gas approval and invalidate the warranty.



ATTENTION: HIGH VOLTAGE!

Before opening the boiler casing for maintenance or servicing, the 230 VAC main supply to the boiler must be disconnected!

SAFETY GUIDELINES

SERVICE

Should you require any assistance during installation or in the unlikely event of a product failure please do not hesitate to contact our technical department on **03452 60 60 20**.

GENERAL RESTRICTIONS

Mikrofill products should always be used, installed and maintained in accordance with the statutory requirements, specifications and standards applicable to these installations. Mikrofill cannot be held responsible for any losses or damage whether direct or consequential that have arisen as a result of incorrect or poor installation.



WARNING!

Particular attention must be given to the safety guidelines as non-compliance will render the warranty void and may constitute an illegal installation.

Detailed recommendations are contained in the following Standards and Codes of Practice:

- **BS 5854** Flue and Flue Structures in Buildings.
- **BS 6644** Installation of Gas Fired Hot Water Boilers of Rated Inputs between 70kW and 1.8MW (net) (2nd and 3rd Family Gases).
- **BS 6880** Low Temperature Hot Water Heating Systems of Output greater than 45kW.
 - **Part 1:** Fundamental and Design Considerations.
 - **Part 2:** Selection of Equipment.
 - **Part 3:** Installation, Commissioning and Maintenance.
- **IGE/UP/1** Soundness Testing and Purging of Industrial and Commercial Gas Installations.
- **IGE/UP/2** Gas Installation Pipework, Boosters and Compressors on Industrial and Commercial Premises.
- **IGE/UP/10** Installation of Gas Appliances in Industrial and Commercial Premises.

DESCRIPTION

GENERAL

The Mikrofill ETHOS floor standing boilers are environmentally friendly gas fired heating boilers with a modulation range between approximately 10% and 100% of their maximum output. The appliances have low NO_x and CO emission, which satisfies the most stringent environmental requirements.



The ETHOS range has received CE approval for all relevant European countries and has been registered under the Product Identification Number 86CL109.

The boilers may only be used on open (type B23) systems.

The boiler is delivered fully wired, fully assembled, tested and preset complete with emissions report.

WORKING PRINCIPLE AND DESIGN

Air is drawn in as required, via a variable speed fan. The gas valve measures the negative pressure (draught) in the venturi and modulates the gas valve in response. The gas and air is then thoroughly mixed in the correct ratio in the fan housing and fired directly into the burner.

The boiler management system compares the actual water flow temperature to the required water temperature. The management system computes the load required and adjusts the fan speed. This is a continual process during operation.

The heat transfer takes place in a stainless steel triple heat exchanger block. The burner fires into the primary heat exchanger whilst the second heat exchanger (condenser) is connected downstream in such a manner that the condense water cannot enter the primary heat exchanger, all heat exchangers consist of several smooth pipes in the form of a coil and are connected using stainless steel water distribution manifolds.

APPLICATION FEATURES

The design of the boiler incorporates the following:

- Full Operation and Fault Diagnostics via LCD.
- Control / High Limit Sensors.
- Integral DHW Control (DHW Input Signal Required).
- Integral Safety Relief.
- Integral Weather Compensation (Optional External Sensor Required).
- Frost Protection.
- Pressure Read Out.
- Compatible with most External BMS Options.

DESCRIPTION

FRONT VIEW:

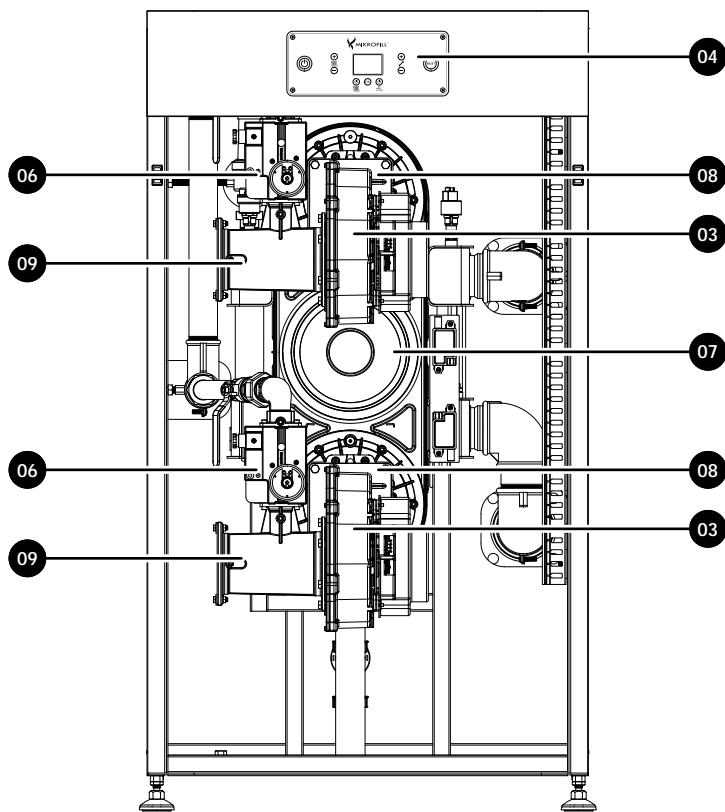

REAR VIEW:

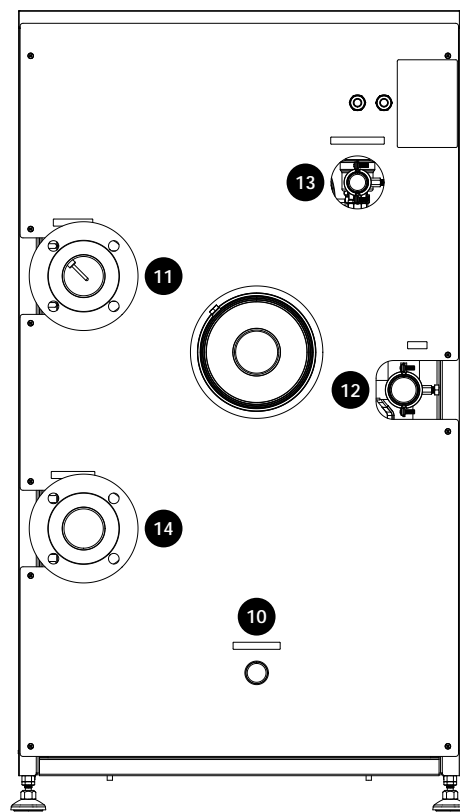

TOP VIEW:

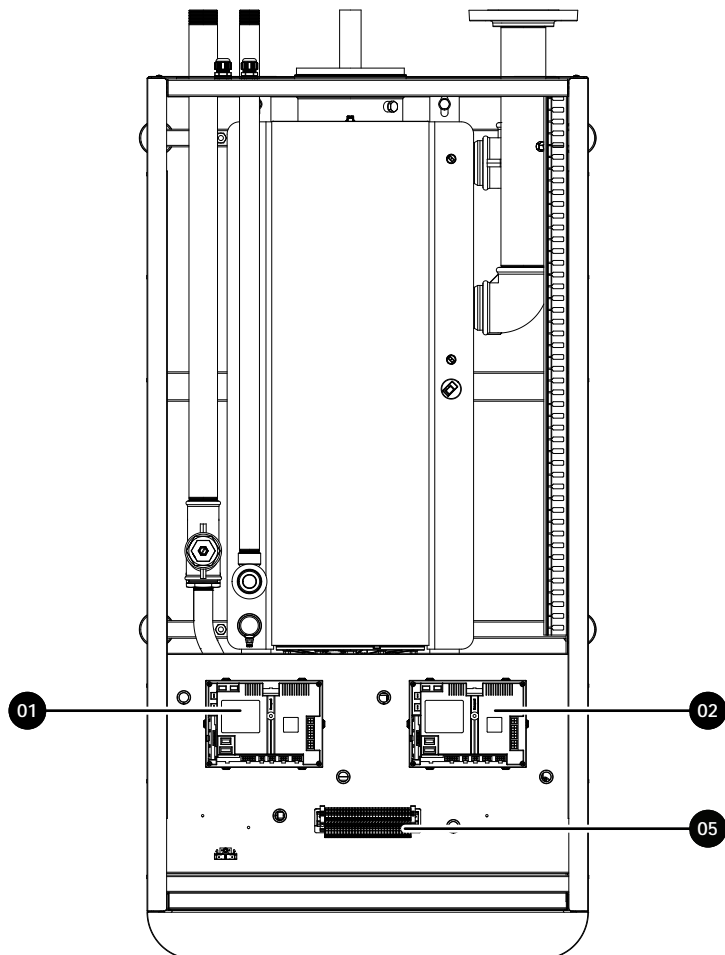

MAIN COMPONENTS:

- 01 Burner #00 Control Unit
- 02 Burner #01 Control Unit
- 03 Combustion Fan
- 04 Control Fascia
- 05 Electrical Connections
- 06 Gas Valve
- 07 Heat Exchanger and Burner Package
- 08 Flap Valve
- 09 Venturi

REAR CONNECTIONS:

- 10 Condense Outlet
- 11 Flow Connection
- 12 Gas Connection
- 13 Pressure Relief Valve Outlet
- 14 Return Connection

DESCRIPTION

BOILER CONTROL

If there is a heat demand, and if all necessary conditions have been fulfilled and all safety devices are satisfied, the boiler will start. This heat requirement will arise if:

- the flow temperature of the boiler is less than the required flow temperature.
- the frost protection has been triggered independently of the operating conditions.

The boiler control unit adjusts the boiler output by changing the fan speed such that the desired temperature is attained and maintained. The actual flow temperature is controlled within 4°C of the target temperature.

SAFETY ASPECTS

The following safety devices are installed on the boiler:

- Temperature Monitoring System.
- High Limit Temperature Monitoring System.
- Limit Temperature Monitoring System.
- Flame Monitoring by means of Ionisation Measurement.
- Fan Speed Monitoring.
- Flow Monitoring using a Flow Water Temperature Sensor.

If one of these safety systems is activated, the boiler will go to an interlocking or lockout condition and will be switched off. Lockout conditions can only be reset by pressing the reset button, after rectifying the fault.

DELIVERY & TRANSPORT

DELIVERY

The boiler is delivered fully assembled, tested and packed.

- Check the boiler for damage upon receipt.
- Check whether the items delivered are correct and in accordance with the items ordered.

TRANSPORT

The packing should only be removed after transportation.

MOVING

Each boiler is packed in its own carton. Refer to the technical data for dimensions and weights in order to work safely within the Health and Safety guidelines when handling these products.

ACCESS REQUIREMENTS

The dimensions are such that all ETHOS floor standing boilers can be transported through a standard doorway.

INSTALLATION

REGULATIONS

The appliance should be installed by a competent installer in accordance with the applicable national and local standards, rules and regulations (please refer to **pages 06** and **07** for safety guidelines).

INSTALLATION GUIDELINES

The following guidelines should be complied with;

- The device should be installed in a frost free room due to the risk of freezing of the condensate drain.
- The built-in protection system is activated when the temperature of the central heating water falls below 5°C.
- Ensure that there is sufficient room around the device for maintenance and the replacement of components if necessary.
- Ensure the base / floor has sufficient load bearing capabilities for the boiler and any other equipment when full of water.

The recommended minimum clearances are as follows:

- 1000mm to the **front** (to allow free space for movement).
- 400mm **above**.
- 100mm at the **sides**.

VENTILATION

The ventilation of the installation room should conform to current gas regulations.

GAS CONNECTION

The gas connection is located on the rear of the appliance (see **page 09**). It should be installed by a competent installer in accordance with the applicable national standards.

A suitable isolation valve should be installed for each boiler and should be in an accessible position. Care should be taken when sizing the pipework to ensure the supply is sufficient for the maximum load operation of the boiler.

The pressure on the inlet side of the appliance should be reduced to 20 mbar for natural gas (G20) and no more than 50 mbar for propane (G31). Under full load conditions the measured gas pressure at the gas valve should be no less than 17 mbar for natural gas (G20) and 30 mbar for propane (G31).

WATER CONNECTIONS

The boiler is designed for sealed systems only and should not be used for open vented systems. For information and sizing of sealed system equipment, please refer to our pressurisation management brochure.

It is recommended that manually operated valves should be installed between the boiler flow and return connections and the system.

It is also recommended that the flow and return pipes are securely fixed with brackets. This prevents damage and makes maintenance easier.

ELECTRICAL CONNECTIONS

The electrical connections should be installed by a competent installer in accordance with applicable national standards.

The appliance is fully wired in accordance with the electrical diagrams delivered with the appliance.

Electrical terminal connections are located at the top of the boiler and are accessed by removing the boiler top panel. Suitable cable entry points are supplied in the form of cable glands.

The appliance is suitable for a 230 V 50 Hz power supply with live / neutral / earth and is polarity sensitive. The installer should use a local two pole isolating switch with a contact opening of at least 3mm in the 230 V supply to the boiler. A permanent earth must also be installed. In order to prevent problems due to electromagnetic radiation, screened cables should be used for all control wiring between the boiler and external management systems. The screening should be earthed on both sides in accordance with current EMC directives.

As the boiler incorporates electrical equipment there is an obligation to the installer to ensure that the boiler is correctly earthed.

0 - 10 V CONTROL

If using the 0 - 10 V control, please ensure that the voltage is driven down to 0 V to disable the boiler(s) and that the 0 - 10 V connection to terminals 12 and 13 is not broken; if broken, the boiler can fire on low fire due to a voltage differential between terminals 12 and 13. Please note that the 0 - 10 V control will override the boiler set point and control via the burner modulation i.e. 10 V = 100%. Please ensure that the control voltage is modulated to prevent the boiler over shooting the required set point.

INSTALLATION

INTERNAL CONTROLS BREAKDOWN (MAIN PCB)

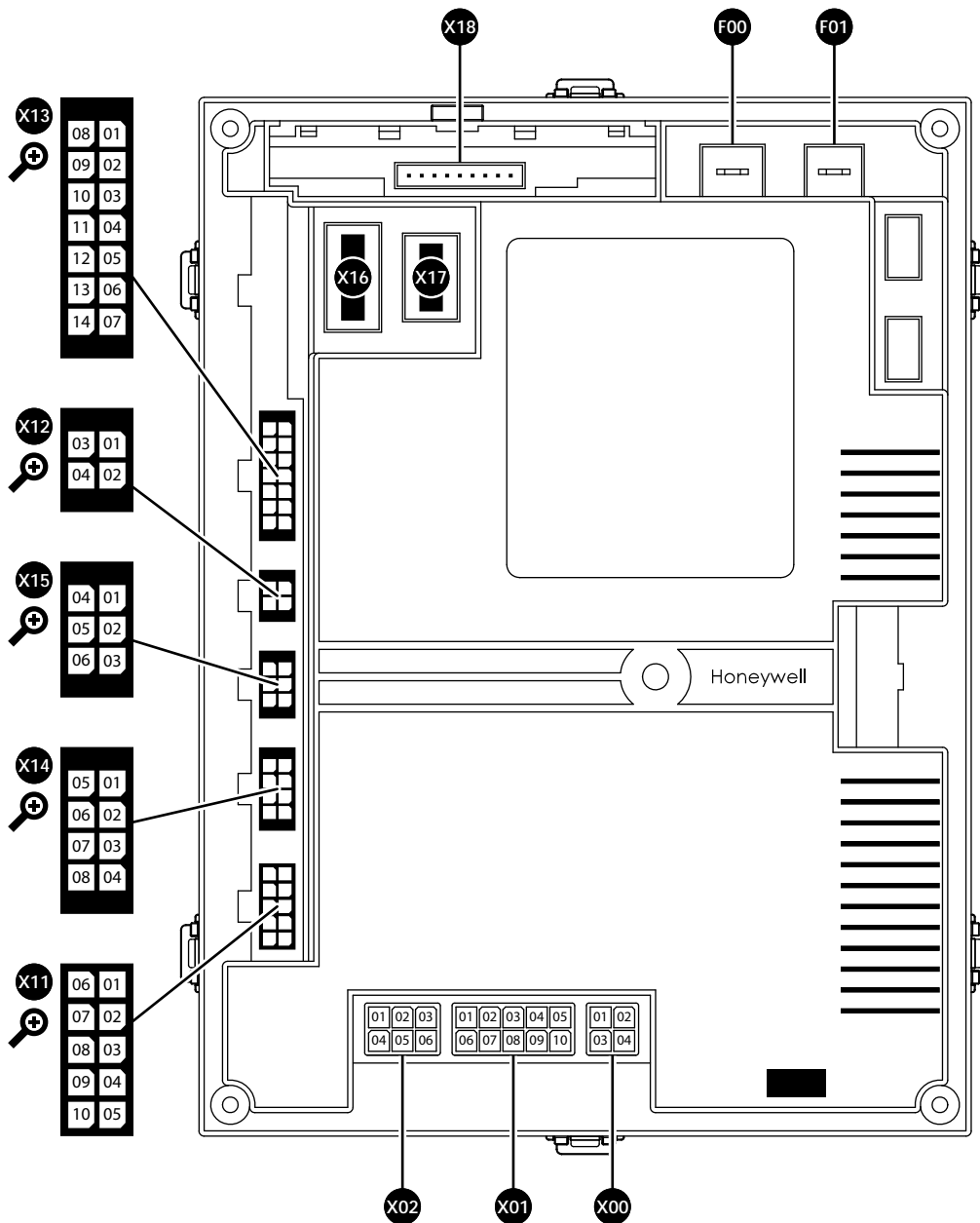

▲ FIGURE 02. TOP VIEW OF MAIN PCB.

- X00 Pin 01: Power to Main PCB
- X00 Pin 02: Power to Main PCB
- X01 Pin 01: Boiler Run Signal
- X01 Pin 02: Pump
- X01 Pin 03: 240 V Output^{[1][2]}
- X01 Pin 04: 240 V Output^{[1][2]}
- X01 Pin 05: Fan Mains
- X01 Pin 07: Pump
- X01 Pin 08: 240 V Output^{[1][2]}
- X01 Pin 10: Fan Mains
- X02 Pin 01: Transformer
- X02 Pin 02: Transformer
- X02 Pin 05: Gas Valve Rectified
- X02 Pin 06: Gas Valve Rectified
- X11 Pin 01: AC Fan Interface
- X11 Pin 02: AC Fan Interface
- X11 Pin 03: Flap Valve
- X11 Pin 06: AC Fan Interface
- X11 Pin 07: AC Fan Interface
- X11 Pin 08: Flap Valve
- X13 Pin 01: Pressure Sensor^[2]
- X13 Pin 02: Pressure Sensor^[2]
- X13 Pin 04: DHW Sensor
- X13 Pin 05: Return Sensor
- X13 Pin 06: Supply Sensor
- X13 Pin 07: Flue Gas High Limit Switch
- X13 Pin 08: Pressure Sensor^[2]
- X13 Pin 11: DHW Sensor
- X13 Pin 12: Return Sensor
- X13 Pin 13: Supply Sensor
- X13 Pin 14: Flue Gas High Limit Switch
- X14 Pin 01: Link to X14 Pin 05^[3]
- X14 Pin 02: Link to X14 Pin 06^[3]
- X14 Pin 05: Link to X14 Pin 01^[3]
- X14 Pin 06: Link to X14 Pin 02^[3]
- X15 Pin 01: Main PCB to Control Fascia^[2]
- X15 Pin 02: Main PCB to Control Fascia
- X15 Pin 03: Main PCB to Control Fascia^[2]
- X15 Pin 04: Main PCB to Control Fascia
- X15 Pin 05: Main PCB to Control Fascia
- X15 Pin 06: Main PCB to Control Fascia

^[1] Used to either power additional pump or motorised valve.

^[2] Only used on **Burner #00**.

^[3] Only used on **Burner #01**.

INTERNAL CONTROLS BREAKDOWN (CONTROL FASCIA)

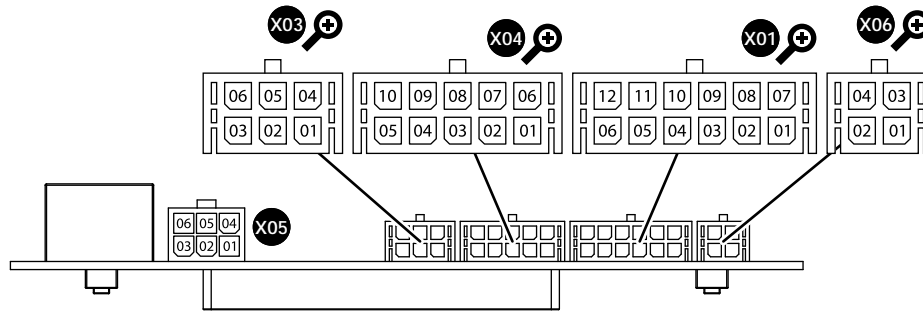

▲ **FIGURE 03.** TOP VIEW OF CONTROL FASCIA.

- **X01 Pin 01:** Control Fascia to Main PCB^[1]
- **X01 Pin 02:** Control Fascia to Main PCB^[1]
- **X01 Pin 03:** Control Fascia to Main PCB^[1]
- **X01 Pin 04:** Control Fascia to Main PCB^[2]
- **X01 Pin 05:** Control Fascia to Main PCB^[2]
- **X01 Pin 07:** Control Fascia to Main PCB^[1]
- **X01 Pin 08:** Control Fascia to Main PCB^[1]
- **X01 Pin 09:** Control Fascia to Main PCB^[1]
- **X01 Pin 10:** Control Fascia to Main PCB^[2]
- **X01 Pin 11:** Control Fascia to Main PCB^[2]
- **X03 Pin 02:** Communication with Master
- **X03 Pin 04:** Communication with Master
- **X03 Pin 05:** Communication with Master
- **X04 Pin 01:** 0 - 10 V DC Input
- **X04 Pin 02:** OpenTherm
- **X04 Pin 03:** OpenTherm
- **X04 Pin 04:** External Sensor
- **X04 Pin 05:** External Sensor
- **X04 Pin 06:** 0 - 10 V DC Input
- **X04 Pin 07:** CH Cascade Sensor
- **X04 Pin 08:** CH Cascade Sensor
- **X04 Pin 09:** Room Thermostat
- **X04 Pin 10:** Room Thermostat
- **X05 Pin 01:** Alarm Output
- **X05 Pin 02:** Alarm Output
- **X05 Pin 05:** Reset
- **X05 Pin 06:** Reset
- **X06 Pin 02:** Communication with Slave
- **X06 Pin 03:** Communication with Slave
- **X06 Pin 04:** Communication with Slave

^[1] Only used on **Burner #00**.

^[2] Only used on **Burner #01**.

EXTERNAL CONTROLS BREAKDOWN (DIN RAIL)

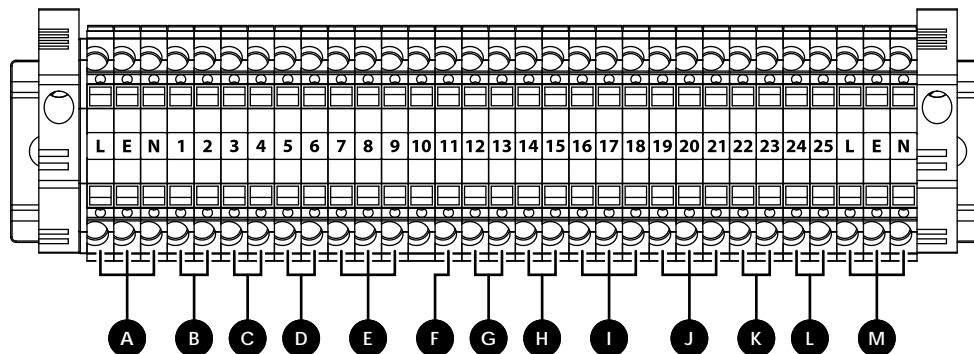

▲ **FIGURE 04.** FRONT VIEW OF DIN RAIL.

- A Live, Earth and Neutral:** Incoming Supply
- B Connections 1 and 2:** Room Thermostat^[1]
- C Connections 3 and 4:** External Sensor
- D Connections 5 and 6:** DHW Thermostat^[1]
- E Connections 7, 8 and 9^[2]:** DHW Output^[3]
- F Connection 11^[4]:** Alarm Output
- G Connections 12 and 13:** 0 - 10 V DC Input^[5]
- H Connections 14 and 15:** OpenTherm
- I Connections 16, 17 and 18:** Communication with Slave
- J Connections 19, 20 and 21:** Communication with Master
- K Connections 22 and 23:** CH Cascade Sensor
- L Connection 24^[4]:** Burner #00 Boiler Run Signal
- Connection 25^[4]:** Burner #01 Boiler Run Signal
- M Live, Earth and Neutral:** Supply to External Pump

^[1] Volt Free Connection (**UNDER NO CIRCUMSTANCES MUST VOLTAGE BE APPLIED TO THESE CONNECTIONS**).

^[2] 240 V Output in no DHW Load Condition.

^[3] Used to either power additional Pump or Motorised Valve.

^[4] 240 V Output.

^[5] Factory fitted link, do not remove unless utilising 0 - 10 V control.

INSTALLATION

CONTROLS AND OPTIONS

The boiler features an automatic fully modulating control system and as such can be used as a 'stand alone' appliance.

The standard controls include;

- 0 - 10 V Input ready.
- Condense Trap Blockage Cut Out.
- Domestic Hot Water Priority Control.
- Frost Protection.
- Low Pressure Cut Out.
- Shunt Pump Overrun Timer.
- Weather Compensation (Optional Sensor Required).

FLUE CONNECTION

The flue gas discharge outlet system should be installed by a competent installer according to applicable national and local standards and specifications. Care should also be taken to ensure compliance with the Clean Air Act.

The boilers are suitable for open type flue systems.

- **Type B23:** Open type appliance without draught stabiliser, air supply from the room, flue gas discharge outlet above the roof.

The flue gas outlet is located at the rear of the appliance and is designed for direct connection to a corrosion resistant flue pipe.

The flue gas discharge pipe to be used should be air tight and water tight at the joints and connections, or should be seamless. Horizontal components in the flue pipe should be installed sloping in the direction of the appliance (minimum 25mm per metre).

The maximum permissible draught on the boiler is 20 Pa.

Care should be taken when making joints to ensure that the seals are not damaged and the joints must be sited to enable access / inspection (GasSafe TB 008 Ed. 2.1).

A direct connection to a brick chimney is not permissible unless a suitable liner is installed.

The following table gives the flue gas data for all types:

		ETHOS 350	ETHOS 550
Average Flue Gas Temperature at Full Load	°C	70	70
Quantity of Flue Gas at Full Load	m ³ /h	651	1023
	kg/s	0.18	0.28
Maximum Permissible Flue Resistance	Pa	200	250

▲ **FIGURE 05.** FLUE GAS DATA / LOAD 100% / FLOW TEMPERATURE 80°C / RETURN TEMPERATURE 60°C

CONDENSE REMOVAL

Drains should be fitted to all flue systems to eliminate excessive condense running through the boiler.

INSTALLATION

FLUE LENGTH

Since the boiler is equipped with a 'premix burner' with a fan, an over pressure is created in the boiler. This over pressure is sufficient to overcome the resistance of the burner, the heat exchanger and the chimney.

The back pressure on the boiler depends on:

- the resistance of the flue pipe.
- the degree of cooling of the combustion gases.
- the resistance of the discharge outlet.

The degree of cooling of the combustion gases depends on the following:

- the insulation value of the flue.
- the ambient temperature.
- the flue system and outlet.

There is a maximum over pressure of around 2.0 mbar (200 Pa) for the **ETHOS 350** and 2.5 mbar (250 Pa) for the **ETHOS 550** in the boiler for the flue gas discharge system.

The maximum draught permissible is 0.2 mbar (20 Pa), this should be checked with the flue warm and boilers not firing. If the draught is above this then flue stabilisers are recommended.

CALCULATION OF DIAMETER AND LENGTH

For the calculation and control of the inner diameter of a discharge system with mechanical discharge, please refer to the applicable national and local standards and regulations.

CONDENSE CONNECTIONS

The boiler includes an anti syphon condense trap enabling the condense pipework to be taken directly to drain. The condense water is slightly acidic (pH 3.0 - 5.5) and should be run in a standard drain pipe material, e.g. acrylonitrile-butadiene-styrene (ABS), polypropylene (PP), polyvinyl chloride (PVC), cross-linked polyvinyl chloride (PVC-C) or unplasticised polyvinyl chloride (PVC-U).

The condensate pipe should ideally run and terminate internally to a soil stack or waste pipe. Alternatively, the condensate can be discharged in to the rainwater system or a purpose-made soakaway. Whichever method is used must conform to applicable national and local standards and regulations. All connecting drainage pipework should have a fall of at least 2.5° to the horizontal, or approximately 25mm per metre of pipe run. If the drainage pipe has external run it should be kept to a minimum length with a minimum diameter of 22mm and be insulated in order to minimise the effects of freezing. It should be noted that connection of a condensate pipe to a drain may be subject to building controls.

SAFETY VALVE CONNECTION

The discharge pipe from the safety valve shall be self draining and terminate in a visible position where the discharge cannot result in hazard to any person or to the plant. The size of the discharge pipe shall be no less than the nominal size of the valve outlet.

HYDRAULIC SYSTEM

The minimum required water circulation over the boiler should be maintained at all times (equivalent to ΔT 25°K at full load). The minimum required water circulation should not be adversely affected by the use of valves, non-return valves, systems in which several boilers are connected to a common distribution pipe etc.

The maximum water flow is achieved at ΔT 15°K.

			ETHOS 350	ETHOS 550
ΔT 20°K	Nominal Flow Rate (Q)	m ³ /h	14.99	23.57
	Boiler Resistance Nominal Flow (R)	kPa	40	35

▲ FIGURE 06. WATER FLOW QUANTITY FOR THE FLOOR STANDING ETHOS RANGE.

The boiler has a pump control circuit to operate an external shunt pump. When the boiler is enabled, the pump is switched on. If the boiler is disabled, the pump will continue to run for a few minutes. The standard run on time is five minutes, but this can be adjusted.

INSTALLATION

SHUT-OFF VALVES

It is recommended that manual valves should be installed between the flow and return connections to the installation.

VALVES (BOILERS IN CASCADE ARRANGEMENT)

To prevent water flow through non-firing boilers, and hence unnecessary heat loss, a spring loaded non-return valve may be installed on the return pipework external to the boiler.

DRAINING AND CLEANING

To drain and clean the boiler, a drain valve must be installed between the boiler and the first valve. Isolate the water and electrical supplies to the boiler and open the drain valve. As there is an automatic air vent on the boiler the water will drain naturally. Please note the bottom coils will not drain fully and water will remain. To clean the water side of the boiler a suitable descaler / deslugger can be used. Please contact our technical department on **03452 60 60 20** for further information.

WATER CIRCULATION SYSTEM

A circulation pump **MUST** be connected to the boiler and the hot water cylinder **MUST** be of the indirect type. The boiler **MUST NOT** be used for direct hot water supply, and single feed, indirect cylinders are not recommended and **MUST NOT** be used on sealed systems. The appliance is **NOT** suitable for gravity central heating nor are they suitable for the provision of domestic hot water.

The hot water cylinder and ancillary pipework, not forming part of the useful heating surface, should be lagged to prevent heat loss and any possible freezing, particularly where pipes run through roof spaces and ventilated underfloor spaces. The boiler must be vented and there must be no low points between the boiler flow connection and a system venting point, which should be positioned as close to the boiler flow connection as is possible.

Draining taps **MUST** be located in accessible positions, which permit the draining of the whole system, including the boiler and hot water storage vessel. They should be at least ½" BSP nominal size and be in accordance with BS2879. Do not use the boiler drain tap to drain the system as this can induce sludge into the heat exchanger.

The central heating system should be in accordance with the relevant standards listed on **page 07**.

Due to the compact nature of the boiler, the heat stored within the heat exchanger at the point of shutdown of the burner must be dissipated into the water circuit in order to avoid overheating. In order to allow pump operation after shutdown, the boiler incorporates a five minute pump overrun facility. In order to make use of this, the pump must be supplied from the terminals inside the boiler. Please note that for pumps requiring greater than 1.0 amp current, they must be connected via a relay / contactor. When sizing pumps, reference should be made to the hydraulic resistance table on **page 19** which shows the boiler resistance against flow rates, to achieve the required temperature differential.

With the boiler firing at maximum rate, the temperature differential should not be less than 10°C. With the boiler firing at minimum rate, the temperature differential should not be more than 35°C. Lower flow rates generating higher temperature differentials may lead to lockouts of the boiler. The lower the return temperature to the boiler, the higher the efficiency. At return temperatures of 55°C and below, the difference becomes marked because the water in the flue gases starts to condense, releasing its latent heat.

In installations where all radiators have been provided with thermostatic radiator valves, it is essential that water circulation through the boiler is guaranteed. A low loss header will perform this task.

WATER PRESSURE

At a maximum flow temperature of 90°C and with the nominal water flow that occurs at a ΔT of 20°K, the minimum operating pressure should be at least 1.5 bar. The operating pressure should be measured when the external pump is switched off. If a lower operating pressure is required, it will be necessary to adjust the maximum flow temperature.

SYSTEM EXPANSION VESSEL

The size of the expansion vessel is determined by the water volume of the system. We recommend that the system expansion vessel is installed on the return pipework in a suitable neutral pressure position.

WATER PRESSURE PROTECTION DEVICE

A 6 bar pressure relief valve is integral within the boiler casing. Should it be necessary to protect the system at a lower pressure, an external safety valve will need to be fitted to the system.

WATER TEMPERATURE

The maximum permissible water flow temperature is 90°C. If the limit thermostat is triggered at 97°C, the boiler will switch off and will automatically restart when the water temperature falls below the limit temperature that has been set. The high limit thermostat is set to 100°C and if activated, the boiler will switch off and not automatically restart when the temperature falls.

WATER QUALITY

The composition and quality of the system water directly affects the performance of any hydronic (water filled) heating system. The life of the boiler and associated equipment will depend on the correct use of water treatments and (when required) deaerators, water filters and / or air and dirt separators. This is particularly important when connecting the boiler into an existing older system.

Care should be taken to ensure that pipework is sound and leaks are eliminated, thus reducing the need for fresh 'top up' water to a minimum.

INSTALLATION

WATER HARDNESS

Water hardness levels are caused by dissolved minerals in the water and will vary geographically. The harder the water, the more likely that problems with precipitation (limescale deposits) will occur, causing permanent damage to the boiler and associated equipment. This is a system fault and is not covered by warranty.

The water hardness is generally expressed in terms of 'ppm' (parts per million) and is sub-divided as follows;

- Very Soft: < 50 ppm
- Soft: 50 - 160 ppm
- Moderately Hard: 160 - 250 ppm
- Hard and Very Hard: > 250 ppm

The system should contain soft to moderately hard water, with a water hardness that does not exceed 250 ppm at a flow temperature of 80°C and ΔT 20°K. Before supplying water, the hardness and chloride value of the system water should always be determined.

The chloride value should never exceed **200mg/litre**.

If the chloride value does exceed this value, the cause should be determined. Compare the chloride value of the supply water and the central heating system water. If this content is much higher, and if no materials containing chloride have been added, this indicates evaporation. If the chloride content is very high, the water is rendered more aggressive (this can be caused by, amongst other things, improperly regenerated water softener). The system should be flushed clean and filled with low chloride water.

In order to counter unnecessary wear and tear and blockages due to impurities present in the system, we recommend the use of a filter system with a mesh size of 100 microns. Always place this in the return line of the secondary part of the system. In order to guarantee a properly working system and long life, one should remove suspended and corrosive particles by installing a suitable filter.

Periodic inspection, including analysis of the system water and cleaning of the filters, should be performed.

OPERATING INSTRUCTIONS

OPERATION

The fan, which is modulated by the temperature controller, supplies the combustion air. Due to the resultant under pressure in the venturi, the zero pressure controller in the gas valve mixes in the required quantity of gas. Gas and air are completely mixed in the venturi, and the gas-air mixture is then fired directly into the burner. The fan also removes the combustion gases. The boiler has no lower limit to the return water temperature. If the temperature is low, condensate will be formed, which is removed via the discharge system.

CONTROLS

Depending on the heat requirement of the system, the boiler output will automatically modulate between 10% and 100% (10:1 turn down ratio). Below 10% load, the boiler operates on / off, based on temperature.





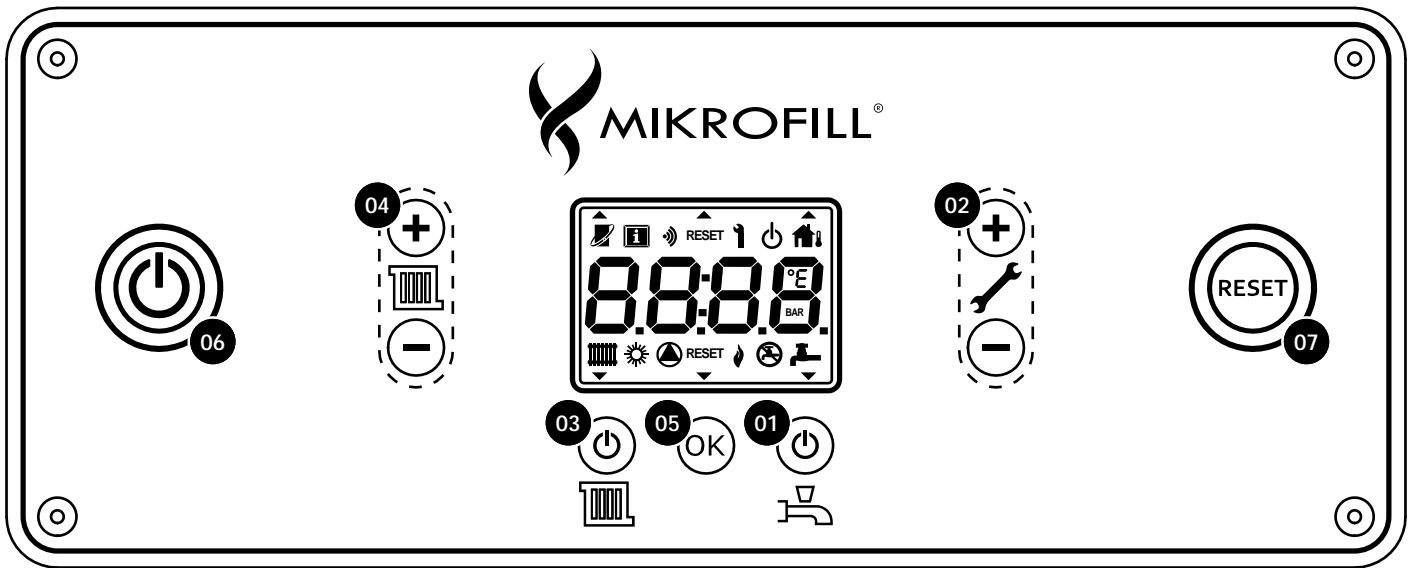







OPERATING INSTRUCTIONS

BOILER MODULE



- 01 DHW Selection
- 02 DHW Temperature
- 03 Heating Selection
- 04 Heating Temperature
- 05 Multi-Function
- 06 Power Switch
- 07 Reset Switch

PCB SYMBOL KEY





	- OpenTherm Connection		- Heating Circuit Active
	- Information		- Summer Mode
	- Wireless		- Pump Active
RESET	- Reset Required		- Burner Operating
	- Engineer Function Active		- DHW Disabled
	- Standby		- DHW Active
	- Frost Protection		

OPERATING INSTRUCTIONS

WARNING:









- The appliance should be installed by a competent installer.
- These operating instructions should be closely followed.
- If the cause of any fault cannot be determined, please contact the technical department.
- Never carry out repairs unless you are a competent and qualified engineer.

SWITCHING ON THE APPLIANCE:

- **STEP 01:** Open the gas valve.
- **STEP 02:** Switch on the boiler using the power switch on the control panel.
- **STEP 03:** Press the   button to enable the heating function.
Press the   button to enable the DHW function if required.

SWITCHING OFF THE APPLIANCE:

The appliance can be switched off in one of four ways:

- **METHOD 01:** The boiler will remain available for hot water operation.
Use the   button.
The heating function will be disabled, whilst leaving the DHW function available.
- **METHOD 02:** The boiler will remain available for heating operation.
Use the   button.
The hot water function will be disabled, whilst leaving the heating function active.
- **METHOD 03:** The boiler will remain on but neither heating or DHW functions are active.
Use the   and   buttons.
Both the heating and DHW functions will be disabled.
- **METHOD 04:** Switch off the boiler completely.
 - **STEP 01:** Switch off the boiler using the power switch on the control panel.
 - **STEP 02:** Close the gas valve.

OPERATING INSTRUCTIONS

INFORMATION DISPLAY:

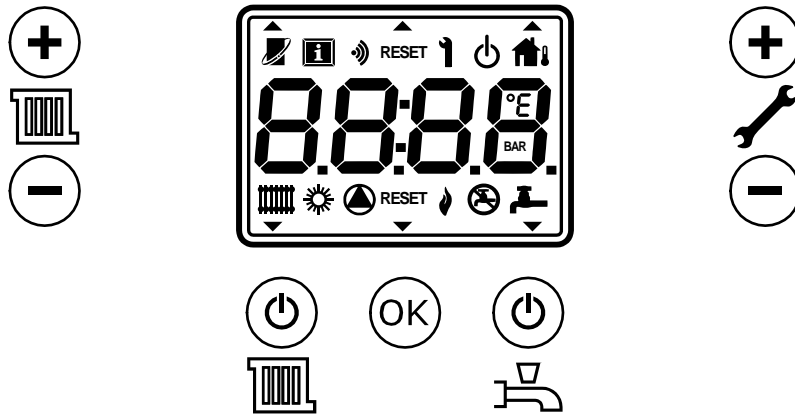

DHW OPERATION

- DHW Mode can be enabled or disabled by using the button.
- The DHW setpoint can be increased or decreased by using the buttons.

HEATING OPERATION

- Heating Mode can be enabled or disabled by using the button.
- The CH setpoint can be increased or decreased by using the buttons.

DISPLAYING INFORMATION









- The installer menu can be accessed by pressing and holding for three seconds.
- The parameter number will then be displayed, followed by the value.
- The next parameter can be viewed by utilising the buttons.

TABLE PARAMETER LIST

INDEX	VARIABLE	UNIT
P01	Flame Current	[μ A]
P02	CH Supply Temperature	[°C -or- °F]
P03	CH Return Temperature	[°C -or- °F]
P04	DHW Temperature	[°C -or- °F] (only on MAXSYS0, if used)
P05	Water Pressure	[bar/10 -or- psi] (local MAXSYS0, where sensor is connected)
P06	Output Level	[rel. %] actual relative output level of the burner
P07	Requested Fan Speed	[50*rpm] speed requested by control algorithm
P08	Actual Fan Speed	[50*rpm] fan speed
P09	Exhaust Temperature	[°C]
P10	Cascade Temperature	[°C -or- °F] if cascade sensor is connected
P11	OTC Temperature	[°C -or- °F] temperature from external sensor
P12	Cascade Modulation Level	[rel. %] relative modulation level of cascade
P13	CH Control Setpoint	[°C -or- °F]
P14	DHW Control Setpoint	[°C -or- °F]
P15	Total Burners	total count of installed burners
P16	Total Burners On	count of burners running
P17	Total Displays	total count of boiler modules

OPERATING INSTRUCTIONS

HISTORY MODE

- To access history mode, press and hold   until the display shows 'Bu 0'.
- Press the  button and the display will flash 'Hi 0'.
- The error code will then automatically be displayed after a few seconds.
- The index number can be cycled using the    buttons.
- To exit history mode, press and hold the   button.

POSSIBLE ERROR CODES

ERROR CODE	DESCRIPTION	RESOLUTION
01	Flame lockout after several ignition attempts.	The boiler has attempted to fire but has not registered an ionisation signal. If the burner is not lighting, then check for an ignition spark and that the gas valve is opening. If the burner is lighting, then the ionisation signal is not being recognised. Check the ionisation probe, cap and cable for continuity and cleanliness. Also, check for continuity on the condensate trap earth pins.
02	False flame signal.	The boiler has detected an ionisation signal when not firing. Check the ionisation probe, cap and cable for continuity and cleanliness.
03	High limit temperature.	The boiler flow temperature has exceeded the high limit temperature. Check for a lack of pressure in the system or a lack of flow, and confirm pump circulation.
05	Fan speed signal not recognised.	A fan speed signal is not being received when the fan is being powered. Check the tacho cable running from the fan to the main PCB, and confirm that the fan is operating.
07	Flue gas temperature sensor limit exceeded.	The flue gas temperature has exceeded the limit temperature. Check the heat exchanger for blockages and for cleanliness. Also, check for system flow.
08	Flame circuit error / loss of flame.	The ionisation signal has been lost during operation. Check for a lack of gas, poor combustion and rectification of the ionisation signal including the ionisation probe, cap and cable.
09	Gas valve circuit error.	The gas valve has failed the circuit test. Check the wiring connections and replace either the valve or cable.
13	Reset error.	The reset has been operated more than five times in fifteen minutes.
15	Supply / return limit error.	The boiler has failed the temperature sensor drift test. The sensor readings have passed outside the allowable limits.
16	Stuck at test error - supply sensor.	The sensor reading has not changed by $\pm 0.25^{\circ}\text{C}$ for 24 hours. The boiler will automatically restart and a second test is carried out lasting 240 minutes. If both tests fail, the boiler will go into a lockout condition. If either test passes, then the boiler will continue to operate.
17	Stuck at test error - return sensor.	
18	Cracked sensor test error.	The sensor has detected a physical crack, replace the sensor.
30	Flow temperature sensor short circuit.	The flow temperature sensor is registering a short circuit. Check the connection to the sensor and replace the sensor if necessary.
31	Flow temperature sensor open circuit.	The flow temperature sensor is registering an open circuit. Check the connection to the sensor and replace the sensor if necessary.
32	DHW sensor short circuit.	The DHW sensor is registering a short circuit. Check the connection to the sensor and replace the sensor if necessary.
33	DHW sensor open circuit.	The DHW sensor is registering an open circuit. Check the connection to the sensor and replace the sensor if necessary.
34	Low incoming mains voltage.	The incoming voltage has dropped below 157 V. Investigate and rectify the incoming mains voltage issue.
37	Water pressure too low.	The internal pressure sensor has detected that the water pressure has dropped too low. Check the water pressure and increase it if necessary. Check the sensor for a blockage.

continued on page 27...

OPERATING INSTRUCTIONS

POSSIBLE ERROR CODES continued.

ERROR CODE	DESCRIPTION	RESOLUTION
43	Return temperature sensor short circuit.	The return temperature sensor is registering a short circuit. Check the connection to the sensor and replace the sensor if necessary.
44	Return temperature sensor open circuit.	The return temperature sensor is registering an open circuit. Check the connection to the sensor and replace the sensor if necessary.
45	Flue gas sensor short circuit.	The flue gas temperature sensor is registering a short circuit. Check the connection to the sensor and replace the sensor if necessary.
46	Flue gas sensor open circuit.	The flue gas temperature sensor is registering an open circuit. Check the connection to the sensor and replace the sensor if necessary.
47	Water pressure sensor fault.	The boiler cannot detect the water pressure. Check the wiring to the sensor and replace the sensor if necessary.
78	Flapper does not open.	The air pressure switch has not opened when the fan has run. Check the condition of the flap valve and also check the wiring to the valve.
79	Flapper does not close.	The air pressure switch has not closed after the boiler has finished firing. Check for excessive flue draught and also check the condition of the flap valve.
80	Supply and return sensor reversed.	The return temperature sensor reading is greater than the flow temperature sensor reading. Check for a lack of flow or reverse flow through the boiler.
81	Drift test warning.	A test function is being carried out on the flow and return temperature sensors.
95	Cascade header sensor not connected.	The cascade header sensor has not been detected by the master boiler. Check the wiring to the boiler and the condition of the sensor.
96	Outside air sensor fault.	The boiler has detected a fault on the outside air sensor. Check for connection to the boiler and also check the condition of the sensor.
97	Cascade structure mismatch.	The master boiler has detected a change in the number of connected boilers / burners. Perform an auto detect sequence and check the wiring and condition of other boilers / burners.
98	Communication error between control fasciae.	Communication between two control fasciae has been interrupted. Check the wiring of the control fasciae, and check the fuses and power supplies to the fasciae. Perform an auto detect sequence.
99	Communication error between main PCB and control fascia.	Communication between the main PCB and control fascia has been interrupted. Check the wiring between the main PCB and control fascia, check the fuses on the main PCB, and perform an auto detect sequence. This may require replacement of either the main PCB or the control fascia.

Several checks are included to protect the boiler and its environment. The water pressure sensor is monitored continually for primary water condition checks, temperatures are monitored continually if they are in range, safety times are constantly compared etc.

Any violation of (programmable) limits (and / or internal thermostat functions) will lead to an error / fault warning condition. This condition can be shown on the display and via external controls connections. Severe error (i.e. igniter lockout) will cause a lockout condition which can only be cleared by the reset switch on the boiler control panel. Non severe errors / faults (i.e. sensor out of range) will reset as soon as the cause of the problem is rectified. In case of lockout and blocking conditions, the fan will not operate and the pump, if present, will always be on (only in a case of low water pressure will the pump be disabled).

COMMISSIONING

GENERAL

The commissioning should only be carried out by qualified personnel. The guarantee may be void if this is not adhered to.

Before operating the appliance, the following should be done:

- Switch off the electrical power supply of the appliance.
- Remove the casing front panel.
- Check the leak tightness of the gas connection.
- Check whether the electrical connection, including earthing, has been correctly made.
- Also, check whether the phase (L) has been connected properly. The boiler is phase sensitive.
- Fill the appliance and system with water.
- Fill the condensate trap with water.
- Check the flue gas discharge connection and, if present, the air supply connection.
- Open the gas valve and vent the gas pipe.
- Switch on the electrical power supply of the appliance.
- Check the external shunt pump.
- Check the boiler at maximum load.

Start the boiler. Allow the boiler to run and stabilise (around three minutes). At full load, the following settings should be checked and corrected if necessary:

REFERENCE VALUE FOR MAXIMUM LOAD

Reference value for CO ₂ :	8.4% ± 0.2	ETHOS 350 - 550	(natural gas)	G20
	9.5% ± 0.2	ETHOS 350	(natural gas)	G25
	8.5% ± 0.2	ETHOS 550	(natural gas)	G25
	9.4% ± 0.2	ETHOS 350 - 550	(propane)	G31

Measure the gas pressure before the gas valve. At maximum load, this must be at least 17 mbar for natural gas and 30 mbar for propane. If there are several boilers, this pressure should be measured with all boilers operating at maximum load.



Check the water side temperature difference (ΔT) between the flow and return connections of the boiler. The ΔT should be between 15°K and 25°K at full load.

Check the boiler at minimum load. At minimum load, the following settings should be checked and corrected if necessary:



REFERENCE VALUE FOR MINIMUM LOAD

Reference value for CO ₂ :	8.4% ± 0.2	ETHOS 350 - 550	(natural gas)	G20, G25
	9.4% ± 0.2	ETHOS 350 - 550	(propane)	G31

MAXIMUM LOAD ADJUSTMENT

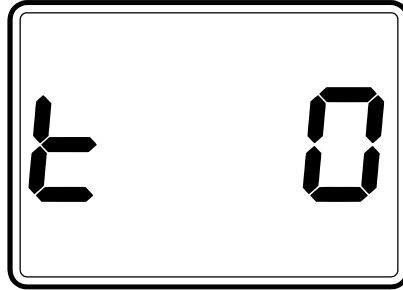

Press and hold the   button for three seconds until the below display appears, the boiler will then start to operate at minimum load.



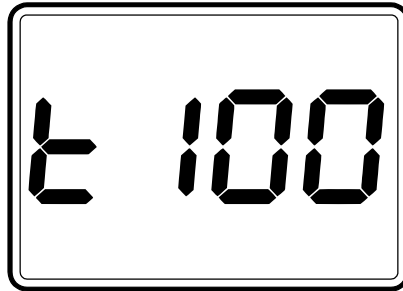

To adjust to maximum rate, press and hold   until the below display appears, the boiler will then start to operate at maximum load.

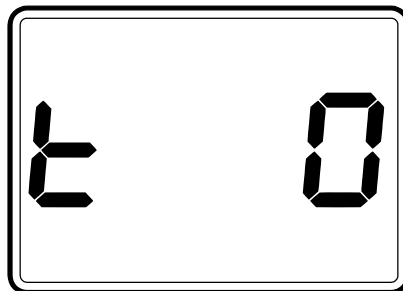

MINIMUM LOAD ADJUSTMENT

Press and hold the   button for three seconds until the below display appears, the boiler will then start to operate at minimum load.



If the boiler is already operating at maximum load (displaying 't 100'), then press and hold   until the display reads as above.

To return to normal operating mode, press and hold   for three seconds until the boiler returns to the temperature display.

Press   to switch between the bottom and top burners.

COMMISSIONING

SETTING THE CO₂ VALUE FOR THE ETHOS RANGE

- Any adjustments should only be carried out by competent persons.
- After adjustment of the gas valve the adjusters must be resealed.

There is a setting screw on the gas valve with which the CO₂ value can be set at maximum load. Set the boiler at maximum load and check the CO₂ value. If necessary, adjust the flat setting screw; clockwise gives less CO₂, anti-clockwise gives more CO₂.

There is a Torx setting screw on the gas valve with which the CO₂ value can be set at minimum load. Set the boiler at minimum load and check the CO₂ value. If necessary, adjust the Torx setting screw; clockwise gives more CO₂, anti-clockwise gives less CO₂.

After the CO₂ values have been set, they should be checked once again and corrected if necessary.

GAS VALVE:

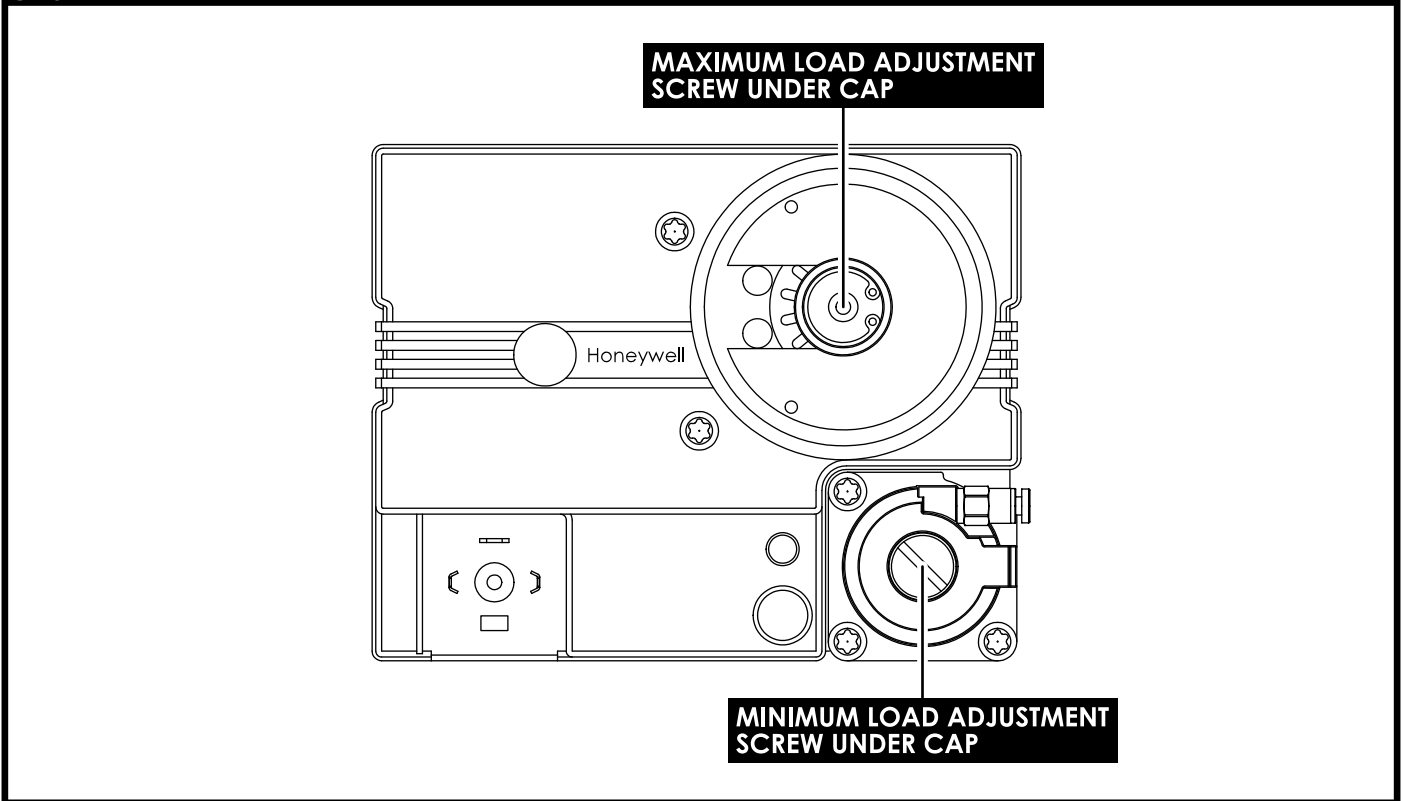

FLUE GAS ANALYSER TEST POINT:

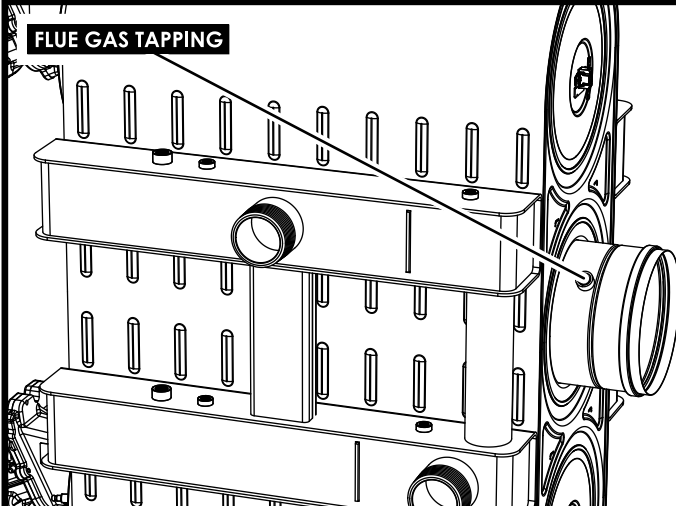

When setting the CO₂ levels on the boiler, the readings can be taken from the flue gas tapping. Unscrew the stop end cap located in the flue gas tapping and insert the gas analyser probe.

Upon completion of tests, ensure that the stop end cap is screwed back into the flue gas tapping.

COMMISSIONING



CONVERSION FROM NATURAL GAS TO PROPANE

For natural gas to propane conversion, it is only necessary to change the gas volume by altering the CO₂ values as described on pages 28 - 30.

CASCADE SET-UP

AUTO DETECTION MODE

Cascade structure will need to be auto detected prior to cascading the boilers. Once the boilers have been detected as indicated below, the number of burners can be confirmed by following the steps below.

- Press and hold the   button for three seconds and the display will show:

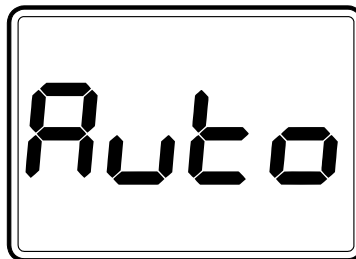

- Once the additional boilers have been identified, the display will change again to indicate it is loading the parameters to the slave boiler(s).

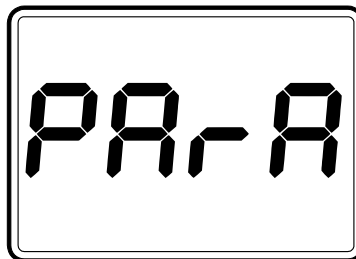

- Once these have been loaded, the master boiler will then request confirmation of the total number of burners.
- This can be confirmed by pressing the  button.
- Once confirmed, the master boiler will display the normal control display and the slave boiler(s) will display 'SLA' and then the boiler number.

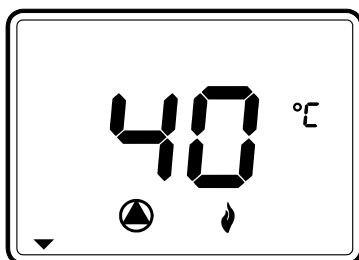

MASTER BOILER

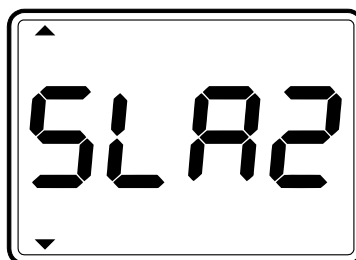

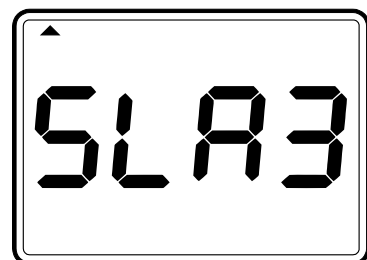

SLAVE BOILER 01



SLAVE BOILER 02

CASCADE SET-UP

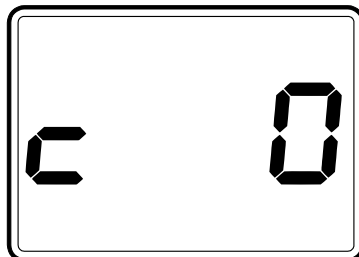

CASCADE TEST MODE

- Press and hold the   and  buttons together for three seconds.
- This will send a request to the master boiler to fire all slave boilers.

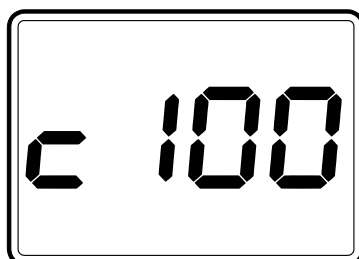

- This can be increased to 100% by pressing the   button until the display below is shown.



- This test mode can be cancelled by pressing and holding the   and  buttons again.
- These buttons should be held until the display returns to the standard display.

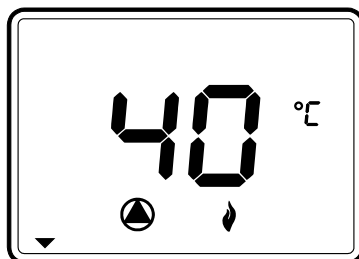

SAFETY

Maintenance should only be carried out by competent persons. Always isolate the gas supply at the gas service valve and isolate and disconnect the electrical supply prior to the removal of any components. Ensure that all external controls are isolated. After completion of maintenance or component replacement the following should be checked:

- Test for gas soundness.
- Check the water system is correctly filled and free of air. Air in the boiler could cause damage to the heat exchanger. For this reason, the automatic air vent in the **ETHOS 350** and **550** must be left open.
- With the system hot, check the boiler for signs of water leakage.
- Check the gas rate and measure the CO₂ content to ensure it is within the specified range. Adjust if necessary (see **COMMISSIONING** section on **page 28**).
- Carry out functional tests.
- If in the unlikely event there is a component failure, please refer to **pages 34** and **35** for instructions on removal of major components.

SERVICING SCHEDULE

To ensure the safe and efficient operation of the appliance, it is recommended that it is checked at regular intervals and maintained as necessary. The frequency of maintenance will depend upon the installation condition and usage, but should still be carried out at least annually. Mikrofill Systems Ltd. does not accept liability resulting from the use of unauthorised components for the repair and maintenance of appliances not in the companies recommendations and specifications.

- Light the boiler and carry out function checks, noting any operational faults.
- Run the system up to operating temperature then check the gas consumption rate. Refer to **page 29** for how to operate the boiler at maximum rate.
- Connect a suitable flue gas analyser to the flue gas test point (see **page 30**) and check the CO₂ values are within those specified in the **COMMISSIONING** section. If the values are correct and the CO / CO₂ ratio is within legal limits, then no further action is required. If the values are incorrect, remove and clean the burner as described on **page 35**.
- Inspect the heat exchanger. If there are any signs of debris, vacuum the heat exchanger and flush through with water.
- Inspect the ignition electrodes and ionisation probes, and replace if necessary.
- Flush the condensate trap through with water.
- Check that the flue terminal is unobstructed and that the flue system is sealed correctly.
- After completing maintenance, carry out safety checks as described above.

MAINTENANCE

REMOVAL OF GAS VALVE AND VENTURI

- Isolate the gas and electrical supplies to the boiler.
- Remove the four screws from the flange on the rear of the gas valve (01).
- Remove the electrical connection on the gas valve (02).
- Remove the six bolts from the venturi / fan (03).
- Remove the gas valve / venturi assembly from the boiler.
- To separate the gas valve and venturi, remove the four screws on the assembly (04).
- Replace in reverse order ensuring all seals / gaskets are in good condition (renew if necessary).

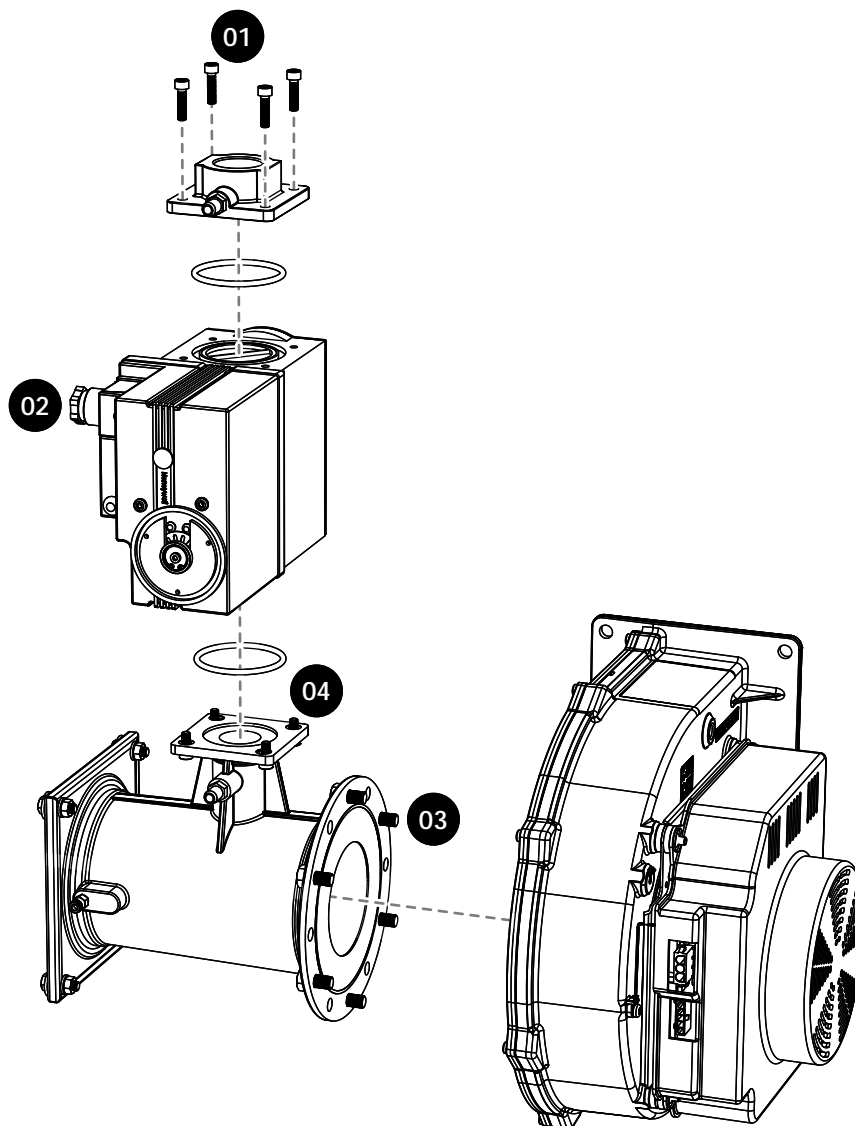

REMOVAL OF FAN AND BURNER ASSEMBLY

- Isolate the gas and electrical supplies to the boiler.
- Remove the caps from the ignition electrode and ionisation probe.
- Remove the two electrical connections from the fan.
- Remove the gas valve and venturi as described on **page 34**.
- Remove the six mounting nuts from the burner door (01).
- Extract the fan / burner assembly.
- To separate the fan from the burner, remove the four bolts from the fan (02).
- Replace in reverse order ensuring all seals / gaskets are in good condition (renew if necessary).

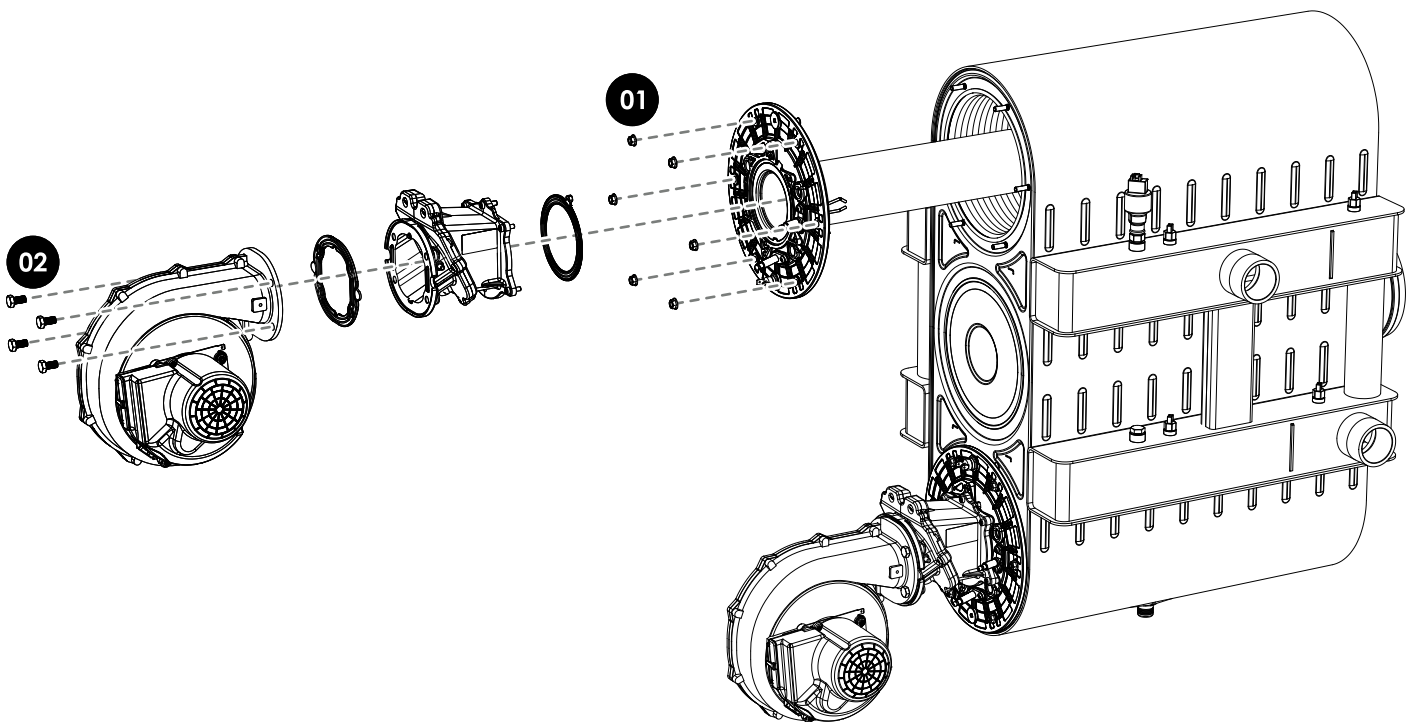

MAINTENANCE

SETTING / CHECKING OF IGNITION ELECTRODE AND IONISATION PROBE GAPS

In addition to the annual maintenance, please ensure the following is carried out:

- Isolate the gas and electrical supplies to the boiler.
- Check the gaps between the ignition electrode / ionisation probe and burner as indicated below.
- Adjust the gaps as necessary.

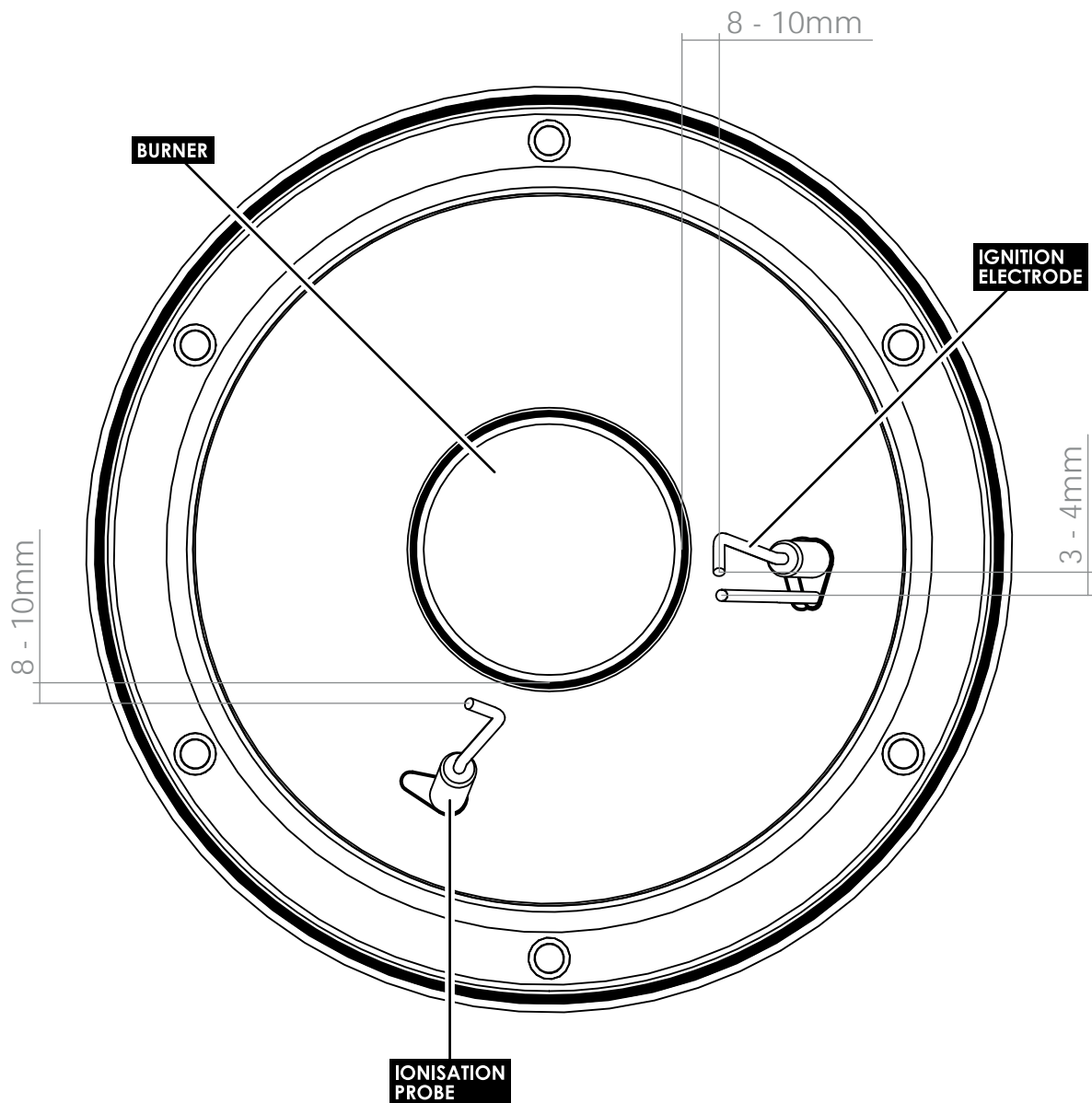

▲ **FIGURE 07.** BACK VIEW OF THE BURNER DOOR.

COMPONENT LIST

Any components within the ETHOS 350 - 550 that may require replacing have been listed in this section, along with their respective part codes. If any part needs replacing which is not listed here, please contact our technical department on **03452 60 60 20** for assistance.

CASING AND ELECTRICAL COMPONENTS

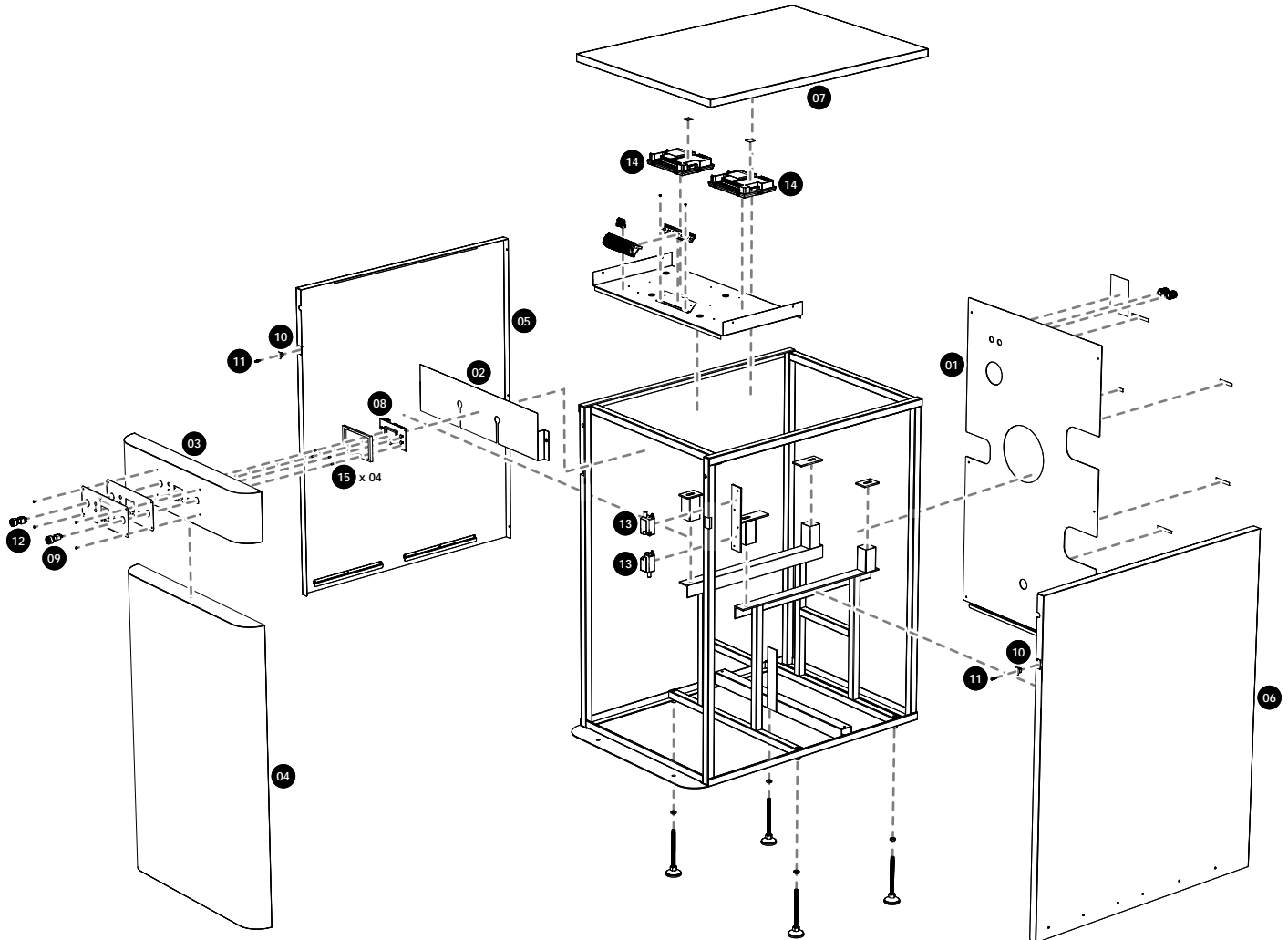

▲ **FIGURE 08.** EXPLODED DRAWING DETAILING THE CASING AND ELECTRICAL COMPONENTS OF THE ETHOS 350 - 550.

"(PART CODE) PART NAME":

- | | |
|--|---|
| 01 (FSB500043) CASING - BACK PANEL | 08 (WHB000088) CONTROL FASCIA PCB (DSP) |
| 02 (FSB500044) CASING - CONTROL COVER PANEL | 09 (WHB000089) CONTROL RESET SWITCH WITH WIRE SET |
| 03 (FSB500045) CASING - CONTROL PANEL | 10 (WHB000077) DOOR CATCH |
| 04 (FSB500046) CASING - FRONT PANEL | 11 (WHB000078) DOOR PIN (M6) |
| 05 (FSB500047) CASING - LEFT SIDE PANEL (ETHOS 350) | 12 (WHB000091) ELECTRICAL ISOLATION SWITCH |
| (FSB600032) CASING - LEFT SIDE PANEL (ETHOS 550) | 13 (WHB000092) IGNITION TRANSFORMER |
| 06 (FSB500048) CASING - RIGHT SIDE PANEL (ETHOS 350) | 14 (FSB350093) MAIN PCB (MAXSYS) (ETHOS 350) |
| (FSB600033) CASING - RIGHT SIDE PANEL (ETHOS 550) | (FSB550093) MAIN PCB (MAXSYS) (ETHOS 550) |
| 07 (FSB500049) CASING - TOP PANEL (ETHOS 350) | 15 (WHB000085) SPACER 33-3660 (8mm) |
| (FSB600034) CASING - TOP PANEL (ETHOS 550) | |

COMPONENT LIST

CORE COMPONENTS

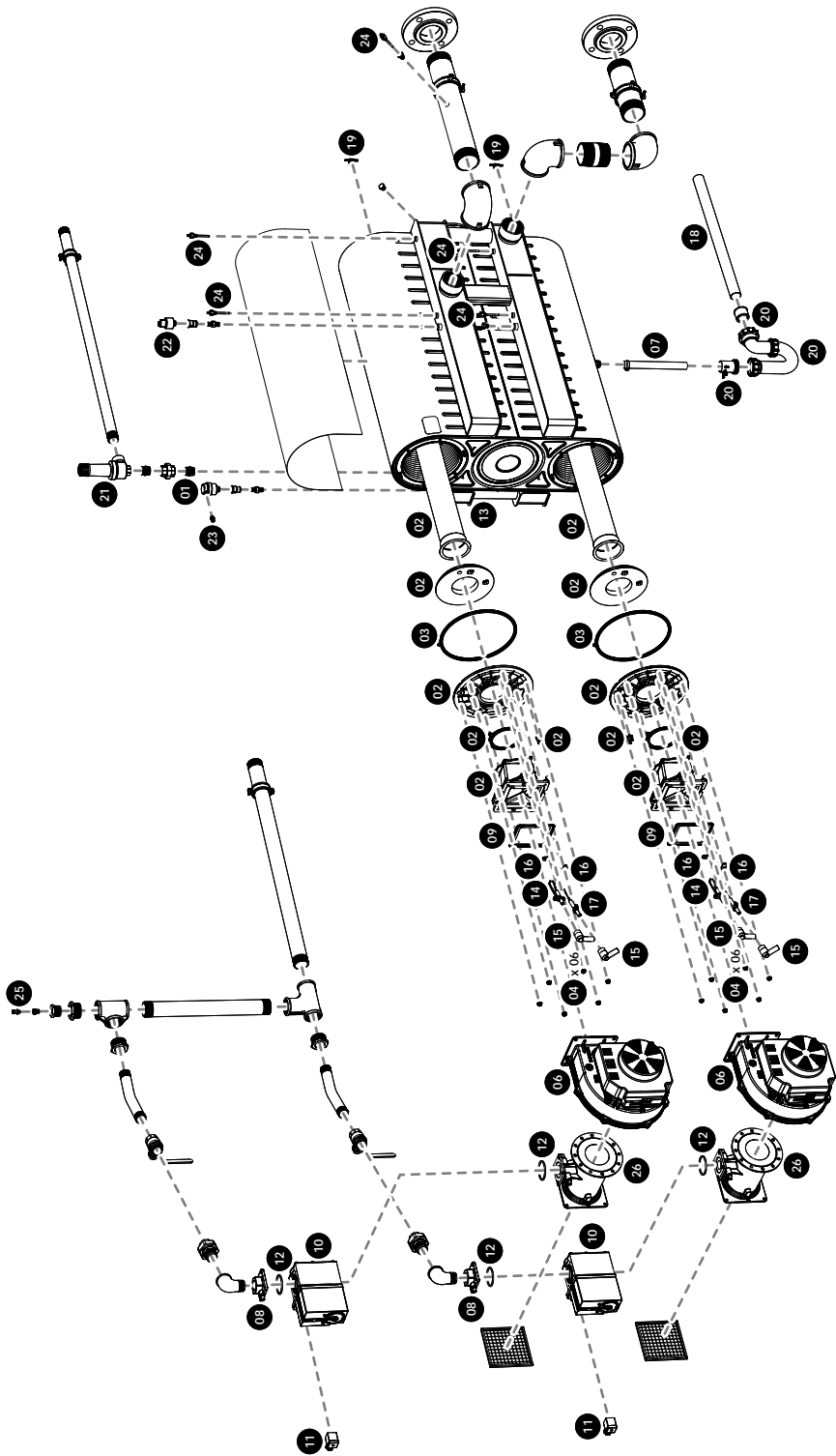

▲ **FIGURE 09.** EXPLODED DRAWING DETAILING THE CORE COMPONENTS OF THE ETHOS 350 - 550.

"(PART CODE) PART NAME":

- 01 (EFD000006) AIR VENT VALVE (¾" MALE)
- 02 (FSB5000089) BURNER DOOR COMPLETE (ETHOS 350)*
- 03 (FSB6000045) BURNER DOOR COMPLETE (ETHOS 550)*
- 04 (FSB5000003) BURNER DOOR GASKET
- 05 (WHB0000002) BURNER DOOR MOUNTING NUT
- 06 (FSB5000007) CLEAR HOSE (AAV TO EXT. DRAIN) (NOT SHOWN)
- 07 (WHB4000003) COMBUSTION FAN RG 175 (ETHOS 350)
- 08 (FSB5000008) COMBUSTION FAN G1G170 (ETHOS 550)
- 09 (FSB6000025) CONDENSATE HOSE (SILICONE) (220mm)
- 10 (FSB5000009) FAN GASKET (ETHOS 350)
- 11 (FSB6000005) FAN GASKET (ETHOS 550)
- 12 (GAV9200001) GAS VALVE (ETHOS 350)
- 13 (FSB6000006) GAS VALVE (ETHOS 550)
- 14 (FSB6000007) GAS VALVE CONNECTOR (88122602)
- 15 (FSB6000008) GAS VALVE GASKET
- 16 (FSB5000010) HEAT EXCHANGER (ETHOS 350)
- 17 (FSB6000009) HEAT EXCHANGER (ETHOS 550)
- 18 (FSB5000012) IGNITION ELECTRODE
- 19 (WHB0000021) IGNITION ELECTRODE / IONISATION PROBE CAP
- 20 (WHB0000022) IGNITION ELECTRODE / IONISATION PROBE GASKET
- 21 (FSB5000013) IONISATION PROBE
- 22 (FSB5000015) OVERFLOW PIPE (Ø 32mm) (350mm) (ETHOS 350)
- 23 (FSB6000013) OVERFLOW PIPE (Ø 32mm) (550mm) (ETHOS 550)
- 24 (GAV9200001) GAS VALVE (ETHOS 350)
- 25 (FSB6000006) GAS VALVE (ETHOS 550)
- 26 (FSB6000007) GAS VALVE CONNECTOR (88122602)
- 27 (FSB6000008) GAS VALVE GASKET
- 28 (FSB5000010) HEAT EXCHANGER (ETHOS 350)
- 29 (FSB6000009) HEAT EXCHANGER (ETHOS 550)
- 30 (FSB5000012) IGNITION ELECTRODE
- 31 (WHB0000021) IGNITION ELECTRODE / IONISATION PROBE CAP
- 32 (WHB0000022) IGNITION ELECTRODE / IONISATION PROBE GASKET
- 33 (FSB5000013) IONISATION PROBE
- 34 (FSB5000015) OVERFLOW PIPE (Ø 32mm) (350mm) (ETHOS 350)
- 35 (FSB6000013) OVERFLOW PIPE (Ø 32mm) (550mm) (ETHOS 550)
- 36 (WHB2000038) OVERHEAT STAT (REAR OF HEAT EXCHANGER)
- 37 (FSB5000090) P TRAP COMPLETE (1½")*
- 38 (FSB5000020) PRESSURE RELIEF VALVE (6 BAR) (¾" - 1")
- 39 (WHB0000030) PRESSURE SENSOR
- 40 (WHB2000011) PUSH FIT - STRAIGHT (CYLINDRICAL)
- 41 (WHB0000038) TEMPERATURE SENSOR (LONG)
- 42 (WHB0000039) TEST NIPPLE (BRASS) (½")
- 43 (VEN9200002) VENTURI (ETHOS 350)
- 44 (FSB6000014) VENTURI (ETHOS 550)

* for details of individual components within this sub-assembly please contact Mikrofill Systems Ltd. on **03452 60 60 20**.

CONVERSION FORMULAE & FACTORS

FORMULAE

$$\text{CO}_2 = \frac{20.9 - \text{measured O}_2}{20.9} \times 11.7$$

$$\text{O}_2 = 20.9 - \frac{\text{measured CO}_2 \times 20.9}{11.7}$$

11.7% CO₂ is the maximum CO₂ percentage that is generated by stoichiometric burning of G20 natural gas (H-gas).

Excess Air N:

$$N = \frac{20.9}{20.9 - \text{measured O}_2} \times 0.914$$

$$N = 1 + \left(\frac{11.7}{\text{CO}_2 \text{ measured}} \right) \times 0.914$$

CONVERSION FACTORS

- For NO_x (N = 1): 1 ppm = 2.05 mg/m³ = 1.759 mg/kWh = 0.498 mg/MJ
- For CO (N = 1): 1 ppm = 1.24 mg/m³ = 1.064 mg/kWh = 0.298 mg/MJ

EXAMPLE

Measured values for an environmentally friendly unit:

- NO_x = 15 ppm
- CO₂ = 10%

What is the value for NO_x according to the most usual standard in mg/kWh for N = 1?

$$\text{O}_2 = 20.9 - \frac{10 \times 20.9}{11.7} = 3\%$$

$$N = \frac{20.9}{20.9 - 3} = 1.17$$

NO_x (for N = 1) =

$$15.0 \times 1.17 = 17.6 \text{ ppm}$$

$$17.6 \times 1.759 = 30.9 \text{ mg/kWh}$$

Watts (W)	kcal/h	Btu/h
1	0.86	3.41
1.163	1	3.97
0.293	0.252	1

▲ FIGURE 10. CONVERSION FACTORS.

- 1 kcal = 4.187 kJ
- 1 kWh = 3.6 MJ

EFFICIENCY AT THE FLUE GAS SIDE

The difference between gross and nett calorific values is the heat of evaporation of the combustion produced water. At 298.15°K (25°C), this is 2442.5 kJ/kg (583.38 kcal/kg).

CONVERSION FORMULAE & FACTORS

FOR NON-CONDENSING BOILERS:

$$nb = 90 - \left(\frac{0.339}{CO_2} + 0.008 \right) \times \Delta T$$

$$no = 100 - \left(\frac{0.377}{CO_2} + 0.009 \right) \times \Delta T$$

FOR CONDENSING BOILERS:

As a result of condensation, the efficiency at the lower value increases.

$$nb = 90 - \left(\frac{0.339}{CO_2} + 0.008 \right) \times \Delta T + A \left(7.5 + 0.006 \Delta T \right)$$

- no / nb = 1.11
- ΔT = Difference in temperature between the flue gases and the environmental temperature ($^{\circ}K$).
- nb = Fuel efficiency at the gross calorific value.
- no = Fuel efficiency at the nett calorific value.
- CO_2 = The volume of CO_2 in the flue gas (%).
- O_2 = The volume of O_2 in the flue gas (%).
- A = The quantity of condensed water in the appliance per m^3 gas in kg (kg/m^3 gas).

	meq/l	$^{\circ}dH$	$^{\circ}f$	$^{\circ}e$	MgCaCO ₃ /l
meq/l	-	1	2.8	5	50
$^{\circ}dH$	0.37	-	1.78	1.25	17.8
$^{\circ}f$	0.2	0.56	-	0.7	10
$^{\circ}e$	0.285	0.8	1.43	-	14.3
MgCaCO ₃ /l	0.02	0.056	0.1	1.54	-

▲ FIGURE 11. DERIVATION OF DEGREE.

- 1 Degree English Hardness ($^{\circ}e$) = 65 mg CaCO₃/imp. gallon
- 1 Grain / US Gallon = 0.958 odH
- 1 milligram equivalent per l (mval/l) = 2.8 odH
- 1 ppm (parts per million) CaCO₃ = 1 mg CaCO₃/l

CE



enmos



MIKROFILL®

INSPIRED EFFICIENCY

Mikrofill Systems Ltd. 11 Merse Road,
North Moons Moat, Redditch, Worcestershire B98 9HL, UK

T +44 (0)3452 60 60 20 **F** +44 (0)3452 60 60 21
E info@mikrofill.com www.mikrofill.com